

LM2900, LM3900 For Specifications, See MC3301 Data.
LM2901 For Specifications, See LM139 Data.
LM2902 For Specifications, See LM124 Data.
LM2903 For Specifications, See LM193
LM2904 For Specifications, See LM158

DUAL DIFFERENTIAL VOLTAGE COMPARATOR

... designed for use in level detection, low-level sensing, and memory applications.

- Two Separate Outputs
- Strobe Capability
- High Output Sink Current
2.8 mA Minimum (Each Comparator) for MC1514
1.6 mA Minimum (Each Comparator) for MC1414
- Differential Input Characteristics
Input Offset Voltage = 1.0 mV for MC1514
= 1.5 mV for MC1414
Offset Voltage Drift = 3.0 $\mu\text{V}/^\circ\text{C}$ for MC1514
= 5.0 $\mu\text{V}/^\circ\text{C}$ for MC1414
- Short Propagation Delay Time — 40 ns Typical
- Output Compatible with All Saturating Logic Forms
 $V_O = +3.2\text{ V to } -0.5\text{ V Typical}$

MAXIMUM RATINGS ($T_A = 25^\circ\text{C}$ unless otherwise noted.)

Rating	Symbol	Value	Unit
Power Supply Voltages	V_{CC} V_{EE}	+ 14 - 7.0	Vdc
Differential Mode Input Voltage Range	V_{IDR}	± 5.0	Vdc
Common Mode Input Voltage Range	V_{ICR}	± 7.0	Vdc
Peak Load Current	I_L	10	mA
Power Dissipation (Package Limitation)	P_D		
Ceramic Dual In-Line Package		1000	mW
Derate above $T_A = 25^\circ\text{C}$		6.0	mW/ $^\circ\text{C}$
Plastic Dual In-Line Package		625	mW
Derate above $T_A = 25^\circ\text{C}$		5.0	mW/ $^\circ\text{C}$
Operating Temperature	T_A	- 55 to + 125 0 to + 75	$^\circ\text{C}$
Storage Temperature Range	T_{stg}	- 65 to + 150	$^\circ\text{C}$

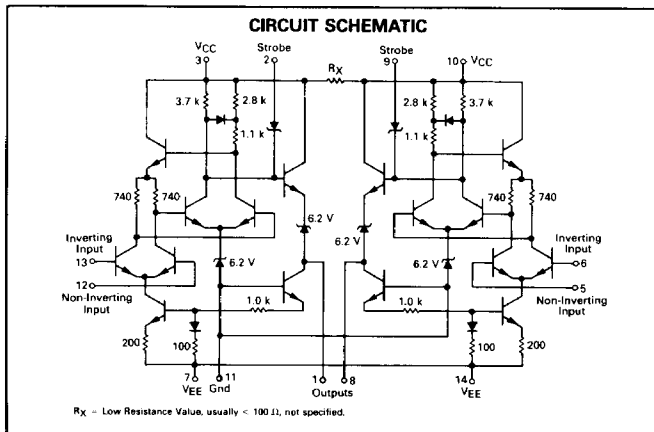

MC1414
MC1514

DUAL DIFFERENTIAL COMPARATOR

(DUAL MC1710)

SILICON MONOLITHIC INTEGRATED CIRCUIT



L SUFFIX
CERAMIC PACKAGE
CASE 632

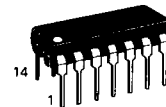

P SUFFIX
PLASTIC PACKAGE
CASE 646
(MC1414 Only)

D SUFFIX
PLASTIC PACKAGE
CASE 751A
(SO-14)
(MC1414 Only)



PIN CONNECTIONS

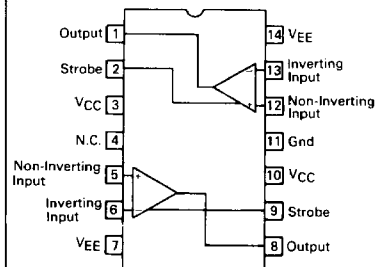

MC1414, MC1514

ELECTRICAL CHARACTERISTICS ($V_{CC} = +12$ Vdc, $V_{EE} = -6.0$ Vdc, $T_A = 25^\circ\text{C}$ unless otherwise noted.) (Each Comparator)

Characteristic	Symbol	MC1514			MC1414			Unit
		Min	Typ	Max	Min	Typ	Max	
Input Offset Voltage ($V_O = 1.4$ Vdc, $T_A = 25^\circ\text{C}$) ($V_O = 1.8$ Vdc, $T_A = T_{low}^*$) ($V_O = 1.0$ Vdc, $T_A = T_{high}^*$)	V_{IO}	—	1.0	2.0	—	1.5	5.0	mVdc
Temperature Coefficient of Input Offset Voltage	$\Delta V_{IO}/\Delta T$	—	3.0	—	—	5.0	—	$\mu\text{V}/^\circ\text{C}$
Input Offset Current ($V_O = 1.4$ Vdc, $T_A = 25^\circ\text{C}$) ($V_O = 1.8$ Vdc, $T_A = T_{low}$) ($V_O = 1.0$ Vdc, $T_A = T_{high}$)	I_{IO}	—	1.0	3.0	—	1.0	5.0	μA dc
Input Bias Current ($V_O = 1.4$ Vdc, $T_A = 25^\circ\text{C}$) ($V_O = 1.8$ Vdc, $T_A = T_{low}$) ($V_O = 1.0$ Vdc, $T_A = T_{high}$)	I_{IB}	—	12	20	—	15	25	μA dc
Open Loop Voltage Gain ($T_A = 25^\circ\text{C}$) ($T_A = T_{low}$ to T_{high})	A_{Vol}	1250 1000	1700 —	— —	1000 800	1500 —	— —	V/V
Output Resistance	R_O	—	200	—	—	200	—	Ohms
Differential Voltage Range	V_{IDR}	± 5.0	—	—	± 5.0	—	—	Vdc
High Level Output Voltage ($V_{ID} \geq 5.0$ mV, $0 \leq I_O \leq 5.0$ mA)	V_{OH}	2.5	3.2	4.0	2.5	3.2	4.0	Vdc
Low Level Output Voltage ($V_{ID} \geq -5.0$ mV, $I_{OS} = 2.8$ mA) ($V_{ID} \geq -5.0$ mV, $I_{OS} = 1.6$ mA)	V_{OL}	-1.0	-0.5	0	—	-1.0	-0.5	Vdc
Output Sink Current ($V_{ID} \geq -5.0$ mV, $V_{OL} \leq 0.4$ V, $T_A = T_{low}$ to T_{high})	I_{OS}	2.8	3.4	—	1.6	2.5	—	mA
Input Common Mode Voltage Range ($V_{EE} = -7.0$ Vdc)	V_{ICR}	± 5.0	—	—	± 5.0	—	—	Vdc
Common-Mode Rejection Ratio ($V_{EE} = -7.0$ Vdc, $R_S \leq 200$ Ω)	CMRR	80	100	—	70	100	—	dB
Strobe Low Level Current ($V_{IL} = 0$)	I_{IL}	—	—	2.5	—	—	2.5	mA
Strobe High Level Current ($V_{IH} = 5.0$ Vdc)	I_{IH}	—	—	1.0	—	—	1.0	μA
Strobe Disable Voltage ($V_{OL} \leq 0.4$ Vdc)	V_{IL}	—	—	0.4	—	—	0.4	Vdc
Strobe Enable Voltage ($V_{OH} \geq 2.4$ Vdc)	V_{IH}	3.5	—	6.0	3.5	—	6.0	Vdc
Propagation Delay Time (Figure 1)	t_{PLH} t_{PHL}	—	20 40	—	—	20 40	—	ns
Strobe Response Time (Figure 2)	t_{so} t_{sr}	—	15 6.0	—	—	15 6.0	—	ns
Total Power Supply Current, Both Comparators ($V_O \leq 0$)	I_{CC} I_{EE}	—	12.8 11	18 14	—	12.8 11	18 14	mA
Total Power Consumption, Both Comparators	P_D	—	230	300	—	230	300	mW

* $T_{low} = -55^\circ\text{C}$ for MC1514, 0°C for MC1414
 $T_{high} = +125^\circ\text{C}$ for MC1514, $+75^\circ\text{C}$ for MC1414

FIGURE 1 — PROPAGATION DELAY TIME

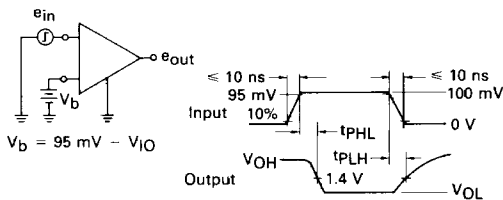
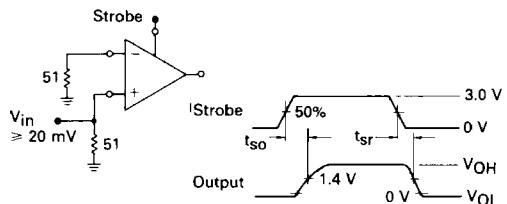

FIGURE 2 — STROBE RESPONSE TIME



MC1414, MC1514

TYPICAL CHARACTERISTICS (Each Comparator)

2

FIGURE 3 — VOLTAGE TRANSFER CHARACTERISTICS

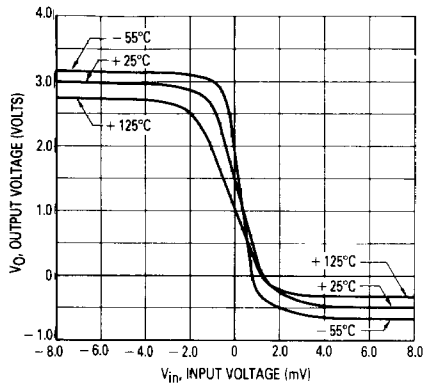

FIGURE 4 — INPUT OFFSET VOLTAGE versus TEMPERATURE

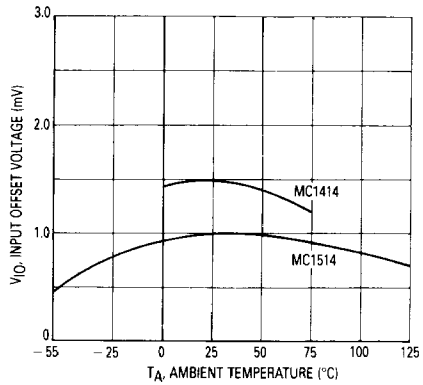

FIGURE 5 — INPUT OFFSET CURRENT versus TEMPERATURE

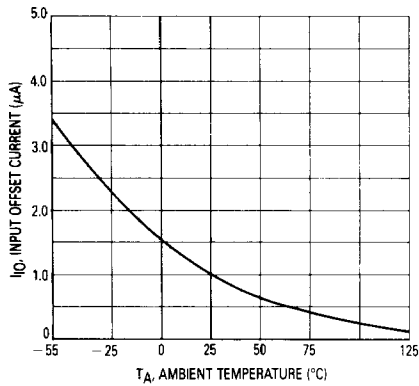

FIGURE 6 — INPUT BIAS CURRENT versus TEMPERATURE

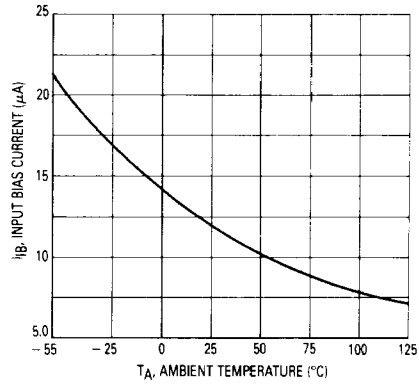

FIGURE 7 — GAIN VARIATION WITH POWER SUPPLY VOLTAGE

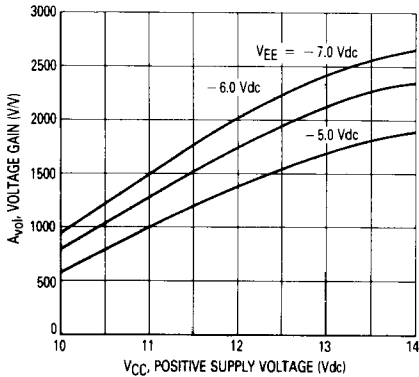

FIGURE 8 — VOLTAGE GAIN versus TEMPERATURE

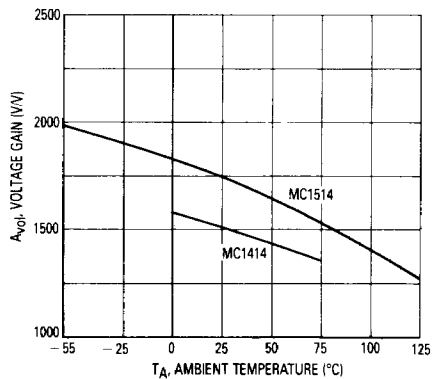

FIGURE 9 — RESPONSE TIME

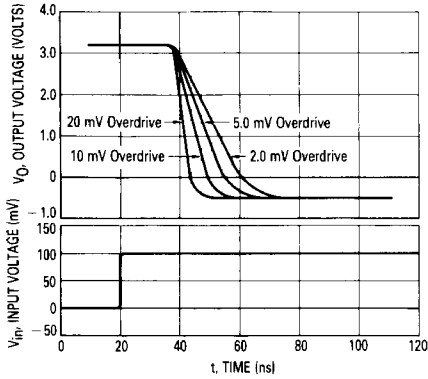

FIGURE 10 — POWER DISSIPATION versus TEMPERATURE

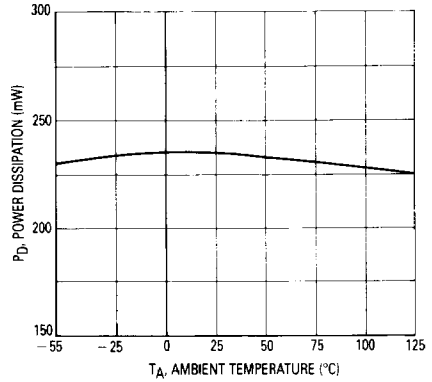

FIGURE 11 — RECOMMENDED SERIES RESISTANCE versus MRTL LOADS

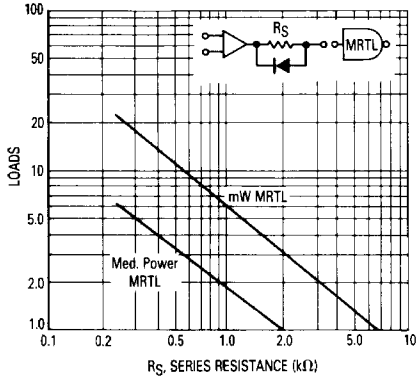

FIGURE 12 — SINK CURRENT versus TEMPERATURE

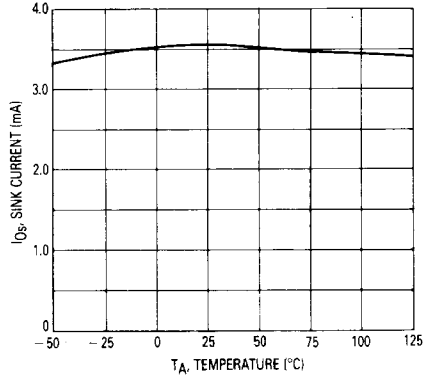
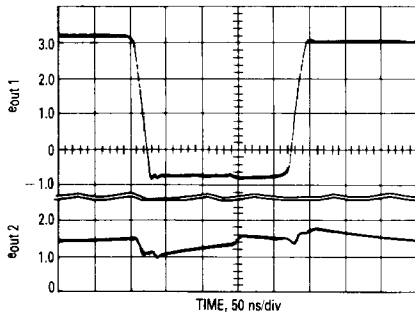
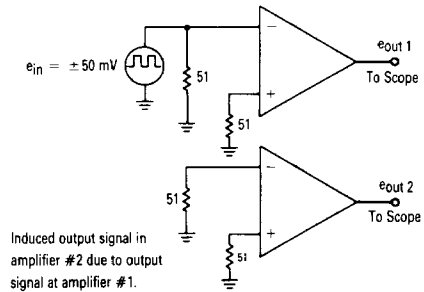

FIGURE 13 — CROSSTALK†



†Worst case condition shown — no load.



This datasheet has been downloaded from:

www.DatasheetCatalog.com

Datasheets for electronic components.