



## A note from the Design Faculty

**W**elcome to the College of Engineering Design Days. The Departments of Computer Science and Engineering, Electrical and Computer Engineering, Mechanical Engineering, and Civil and Environmental Engineering wish you a very memorable experience as our students demonstrate their amazing talents through design competitions, oral presentations, and posters. While paging through the ingenuity which follows, you will notice we are preparing for the addition of yet another group of talented Spartans. Spring, 2009 Design Days will welcome the participation of Chemical Engineering, and as a preview, their course goals can be found within. Design Days clearly demonstrates that MSU engineers are educated to lead, create, and innovate.

As you visit our activities, please interact with our students and faculty. They are an incredible group of people who would love to share with you their accomplishments on display. To add further to the excitement of the day, approximately 300 middle school and high school students are participating in the Dart Foundation Day of Engineering Innovation and Creativity for 7th-12th Grade Students. The students will have the opportunity to explore engineering principles with hands-on projects that require the application of their creativity and ingenuity.

The headliners of Friday are our graduating seniors, as they present their Capstone Design projects through posters and oral presentations. These projects are the culmination of years of education and provide unique opportunities for the seniors to demonstrate all that they have learned and mastered.

Design Days would not be possible without the generous support of our project sponsors and donors. Project sponsors provide not only funding, but, just as important, a professional interaction for our capstone design teams. Donors support the humanitarian projects and the operating costs of Design Days. We thank all for their generosity and time.

**Advancing knowledge**

**Transforming lives**

**Invigorating companies and communities**

Please join us for the Design Day Awards ceremony in the Ballroom at 1:00. This is where we will honor the best of the best,

Wayne Dyksen  
Professor  
Computer Science  
and Engineering

Craig W. Somerton  
Associate Professor  
Mechanical Engineering

Erik D. Goodman  
Professor  
Electrical and  
Computer Engineering

Roger Wallace  
Associate Professor  
Civil and Environmental  
Engineering



# FINDING YOUR WAY TO THE UNION BUILDING...

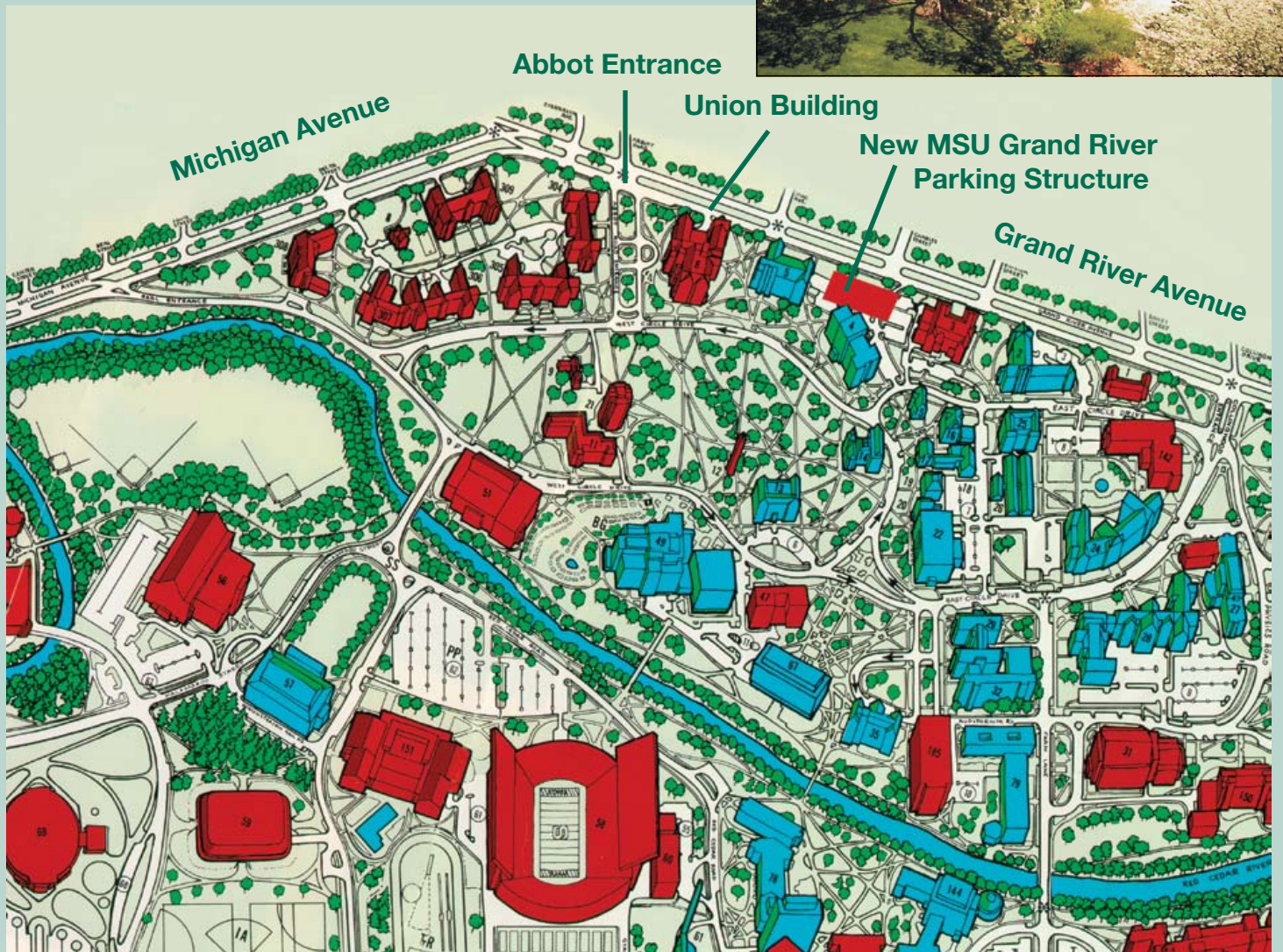

Parking is available in lots and ramps north of Grand River Avenue in the downtown area of East Lansing and on campus in lots with parking attendants. Limited parking for visitors is available in metered areas on campus streets and at the new MSU Grand River Avenue Parking Structure. Buses can park in the large lot south of the football stadium.



Powering Business Worldwide



Dow Automotive



Count on it.

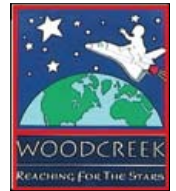

MOTOROLA



TEREX



The Appropriate Technology Design Collaborative



Shell



The Chrysler Foundation



Jeep

lenovo



CHRYSLER



KELD LLC

Microsoft



The MSU College of Engineering

# Design Days

December 2008

MICHIGAN STATE  
UNIVERSITY

design   
program

# Program Page/Course Number

Letter from James D. Lammers, Dart Foundation .....	3
Design Days Events Schedule, Thursday 4 and Friday 5 December, 2008 .....	4
Union Building Floor Plan.....	5
Staff Acknowledgements: College of Engineering Design Days .....	6
EGR 100: Introduction to Engineering Design: <i>Design of Products for College Dorm Rooms</i> .....	8
ME 371: Mechanical Design I: <i>Prototypes of Innovative Machines and Mechanisms</i> .....	9
ME 412: Heat Transfer Laboratory: <i>Solar Hot Air Balloon</i> .....	10
ME 456: Mechatronics Systems Design: <i>Prototypes of Commercial Products</i> .....	11
CE 495/CSE 498: Descriptions of course goals .....	12
ECE 480/ME 481: Descriptions of course goals.....	13
CSE 498 Computer Science & Engineering Projects: Presentation Schedule–Lake Erie Room .....	16
<i>Auto-Owners Insurance Company</i> : Recruiting Contacts & Events System.....	17
<i>The Boeing Company</i> : KML Urban Scene Builder 2008 .....	18
<i>Chrysler, LLC</i> : Performance Feedback System Dashboard.....	19
<i>Ford Motor Company</i> : Ford Test Drive.....	20
<i>IBM</i> : Fixpack Publishing Tool Enhancements.....	21
<i>Microsoft</i> : Application Health Monitoring System .....	22
<i>TechSmith Corporation</i> : Cloud Powered Media Searching.....	23
<i>The Toro Company</i> : Golf Vision Interface for Turf Guard .....	24
ECE 480/ME 481 Engineering Design Projects: Presentation Schedule–Lake Huron Room.....	26
<i>Whirlpool Corporation</i> : Barcode Cooking "GPS" .....	27
<i>Norfolk Southern</i> : Trackside System Sensing/Responding to Changing Conditions.....	28
<i>PI Engineering</i> : Quasi-Motion Ship Simulator .....	29
<i>General Motors</i> : Early Emergency Signal Detection Sound Processing Unit .....	30
<i>Keld, LLC</i> : Battery-Supercapacitor Hybrid Energy Storage System.....	31
<i>A Shell Oil Company Children's Humanitarian Project</i> : A School Supplies Carrier for McKenzie Robins .....	32
<i>Motorola</i> : Keypad-Enabled Product Design for a Mobile Device .....	33
<i>The Motorola Foundation Youth in Energy &amp; Environment Humanitarian Project</i> : Thermal Solar Collector Demonstrator for Woodcreek Elementary School .....	34
<i>A Lear Corporation &amp; Chrysler Foundation Humanitarian Project for Developing Countries</i> : A Vaccine Refrigerator for Remote Regions with the Appropriate Technology Design Collaborative .....	35
CE 495 Senior Design in Civil Engineering–MSU and Lake Michigan Rooms.....	36-37
ECE 480/ME 481 Engineering Design Projects: Presentation Schedule–Lake Superior Room.....	38
<i>Lettuce Duit</i> : Accessible Manufacturing Equipment Automated Material Cutter .....	39
<i>Lenovo Corporation</i> : Solar-powered, Multi-user Internet Access for Schools in Developing Nations.....	40
<i>Naval Research Lab</i> : Inexpensive Radar for Through-Object Viewing.....	41
<i>Terex Corporation</i> : Monitoring Rental Equipment Through Telematics .....	42
<i>Biogeochemistry Environmental Research Initiative</i> : Automated Trace Gas Trapping System .....	43
<i>Nissan</i> : Efficient Engine Undercover and Fender Protector.....	44
<i>Eaton</i> : Next Generation Mylar Fixture.....	45
<i>Dow Chemical Company</i> : Novel Part Design Replacing Fiberglass with TPO .....	46
<i>Dow Chemical Company</i> : Water Pouches .....	47
ME 481 Mechanical Engineering Design Projects: Presentation Schedule–Tower Room.....	48
<i>Kellogg Biological Station Dairy Farm</i> : Alternative Energy Power System for the Kellogg Biological Station Dairy Farm Expansion .....	49
<i>Terex-Demag</i> : Wheel Module Development for All-Terrain Crane .....	50
<i>General Motors</i> : LED Light Pipe Reuse Strategy .....	51
ChE 434 Capstone Spring 2009 and ChE 433 Process Design and Optimization I .....	52
Design Day Awards: Electrical and Computer Engineering, Mechanical Engineering, Computer Science Engineering, Civil and Environmental Engineering and Applied Engineering Sciences .....	55-59
The Dart Foundation Days: December 4th and 5th 2008: Middle School & High School Events Schedule.....	62-63

# Program by Sponsor

Auto-Owners Insurance Company: Recruiting Contacts & Events System .....	17
Biogeochemistry Environmental Research Initiative: Automated Trace Gas Trapping System .....	43
The Boeing Company: KML Urban Scene Builder 2008 .....	18
Chrysler, LLC: Performance Feedback System Dashboard .....	19
Dow Chemical Company: Novel Part Design Replacing Fiberglass with TPO .....	46
Dow Chemical Company: Water Pouches .....	47
Eaton: Next Generation Mylar Fixture .....	45
Ford Motor Company: Ford Test Drive .....	20
General Motors: Early Emergency Signal Detection Sound Processing Unit .....	30
General Motors: LED Light Pipe Reuse Strategy .....	51
IBM: Fixpack Publishing Tool Enhancements .....	21
Keld, LLC: Battery-Supercapacitor Hybrid Energy Storage System .....	31
Kellogg Biological Station Dairy Farm: Alternative Energy Power System for the Kellogg Biological Station Dairy Farm Expansion .....	49
A Lear Corporation & Chrysler Foundation Humanitarian Project for Developing Countries: A Vaccine Refrigerator for Remote Regions with the Appropriate Technology Design Collaborative .....	35
Lenovo Corporation: Solar-powered, Multi-user Internet Access for Schools in Developing Nations .....	40
Lettuce Duit: Accessible Manufacturing Equipment Automated Material Cutter .....	39
Microsoft: Application Health Monitoring System .....	22
The Motorola Foundation Youth in Energy & Environment Humanitarian Project: Thermal Solar Collector Demonstrator for Woodcreek Elementary School .....	34
Motorola: Keypad-Enabled Product Design for a Mobile Device .....	33
Naval Research Lab: Inexpensive Radar for Through-Object Viewing .....	41
Nissan: Efficient Engine Undercover and Fender Protector .....	44
Norfolk Southern: Trackside System Sensing/Responding to Changing Conditions .....	28
PI Engineering: Quasi-Motion Ship Simulator .....	29
A Shell Oil Company Children's Humanitarian Project: A School Supplies Carrier for McKenzie Robins .....	32
TechSmith Corporation: Cloud Powered Media Searching .....	23
Terex Corporation: Monitoring Rental Equipment Through Telematics .....	42
Terex-Demag: Wheel Module Development for All-Terrain Crane .....	50
The Toro Company: Golf Vision Interface for Turf Guard .....	24
Whirlpool Corporation: Barcode Cooking "GPS" .....	27



500 HOGSBACK ROAD  
MASON, MICHIGAN 48854  
PHONE: 800.248.5960  
FAX: 517.244.2631

November 2008

Dear Students, Family Members, Industry Representatives, Alumni, Faculty and Staff:

On behalf of the Dart Foundation it is a great pleasure to welcome you to the Michigan State University College of Engineering Design Days.

This event showcases the work of a very talented group of students from the College of Engineering (many of them working on projects sponsored by industry) and is intended to motivate middle and high school students from around the state to choose engineering as a career. Despite the economic difficulties being experienced around the world, graduating seniors in engineering are still finding excellent and important jobs, in Michigan and beyond.

The Dart Foundation recognizes the importance of exposing young people to the exciting field of engineering. Toward that end we have sponsored the involvement of pre-collegiate students in Design Days for the past four years. The Dart Foundation Days of Innovation and Creativity for 7<sup>th</sup>—12<sup>th</sup> Grade Students engage students in hands-on projects and show them how an engineering education prepares them to solve challenging real-world problems. These middle and high schoolers even participate in judging competitions between the college student teams! This intensive involvement makes their MSU visit a significant experience and helps them see how a career in engineering serves our community, our state, and the world.

Michigan State University will welcome many sponsors and proud parents in the MSU Union during Design Days, and their support is critical to the success of this program. The Dart Foundation joins them in congratulating the students on their remarkable achievements. Our best wishes to all of you for a stimulating and enjoyable experience at Design Days.

Sincerely,

James D. Lammers  
Vice President, the Dart Foundation



### Design Day Events Schedule: Thursday, December 4, 2008

EVENTS	8 a.m.	9 a.m.	10 a.m.	11 a.m.	Noon	1 p.m.
Audio Enthusiasts and Engineers	2nd Floor Concourse 8:00 a.m. – 1:00					
EGR 100 Cornerstone Poster Session		Ballroom (Front) 9:00 a.m. – Noon				
Engineering Student Organizations		2nd Floor Concourse 9:00 a.m. – noon				

### Design Day Events Schedule: Friday, December 5, 2008

EVENTS	8 a.m.	9 a.m.	10 a.m.	11 a.m.	Noon	1 p.m.
Audio Enthusiasts and Engineers	Billiard Room 8:00 a.m. – 1:00 p.m.					
Engineering Student Organizations		2nd Floor Concourse 9:00 a.m. – noon				
ME 371 Demonstrations		Gold A&B 9:00 a.m. - noon				
ME 412 Competition		Parlor A 8:50 a.m. - noon				
ME 456 Presentations		Lake Ontario 9:10 a.m. - 11:30 a.m.				
Capstone Posters	2nd Floor Ballroom 8:00 a.m. - noon					
ECE 480/ME 481 Project Presentations	Lake Huron Room 8:00 a.m. - 12:30 p.m.					
ECE 480/ME 481 Project Presentations	Lake Superior Room 8:00 a.m. - 12:30 p.m.					
ME 481 Project Presentations	Tower Room 8:00 a.m. - 9:15 a.m.					
CSE 498 Project Presentations	Lake Erie Room 8:00 a.m. - 11:40 p.m.					
CE 495 Project Presentations	Lake Michigan Room 8:20 - 12:20 a.m.					
CE 495 Project Presentations	MSU Room 8:20 - 12:20 a.m.					
Woodcreek Lunch			Green Room 12:00 p.m. - 1:00 p.m.			
MSU Lunch			2nd Floor Concourse 12:15 p.m. - 1:00 p.m.			
MSU Awards			Ballroom 1:00 p.m.- 2:00p.m.			
High School Lunch			Parlor C Noon - 12:30 p.m.			

KEY: ■ CE event ■ CSE event ■ EGR event ■ ME event ■ High School event

### Conference Events Schedule: Floor Maps

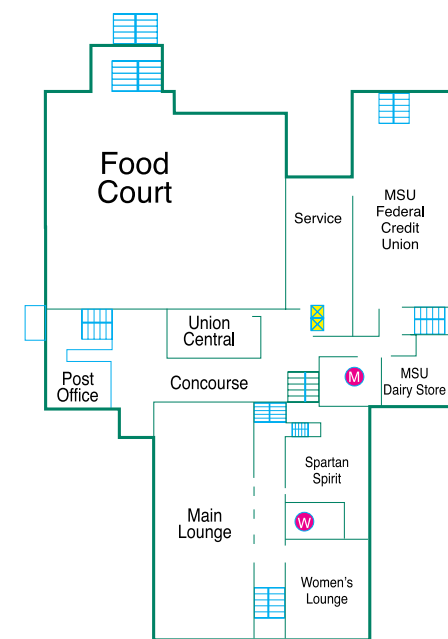

First Floor

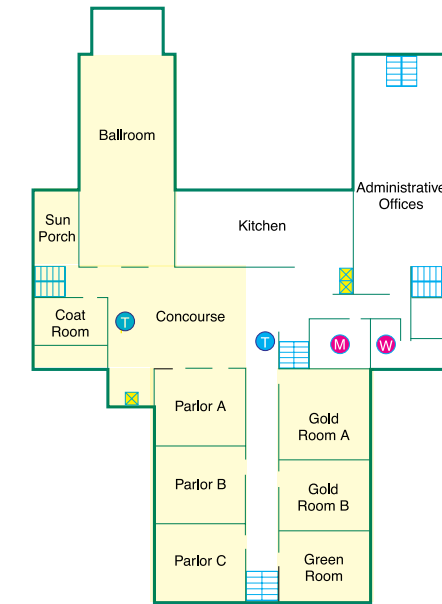

Second Floor

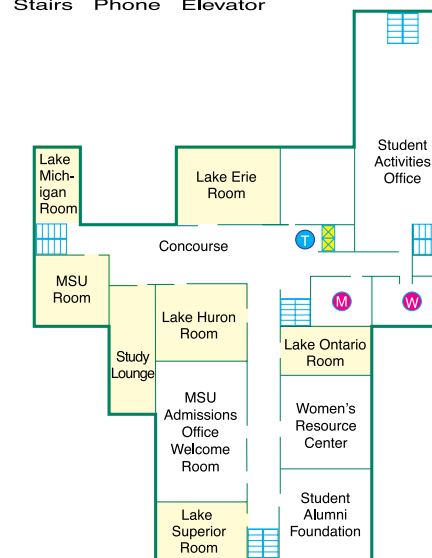
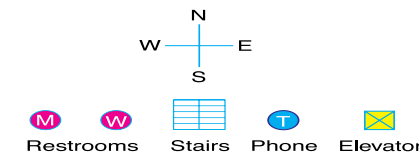

Third Floor

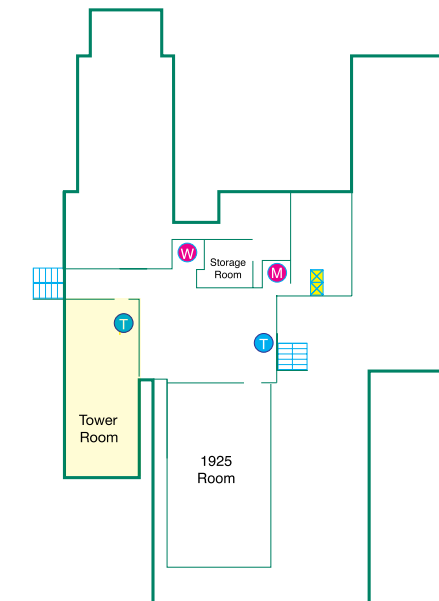

Fourth Floor

### MSU Union Floor Plan

# College of Engineering Design Day: Fall 2008

## STAFF ACKNOWLEDGEMENTS



Maureen Blazer-Adams  
Design Day Coordinator



Roy Bailiff



Jill Bielawski



Linda Clifford



Kelly Climer



Cathy Davison



Craig Gunn

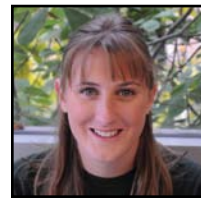

Brittany Haberstroh

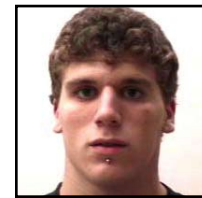

Matt Jennings



Debbie Kruch



Matt Luciw



Jamie Lynn Marks



Elizabeth Meyer



Garth Motschenbacher



Mary Mroz



Gregg Mulder



Roxanne Peacock



Adam Pitcher



Eva Reiter



Norma Teague



Teresa VanderSloot



Brian Wright

### MACHINE SHOP AND DESIGN LAB STAFF:

Ken Barlage



Shell is a proud sponsor of MSU's Senior Design Program.

Congratulations Seniors!

With the wind behind you and open space ahead, there's no limit to the possible directions your career could take. And at Shell, we'll support you all the way.

Our approach is collaborative – matching our business needs with your training needs, our global opportunities with your career aspirations. We aim to build a win-win partnership between you and Shell.

Right from the start, you'll be making a valuable contribution to exciting projects. Your ideas will be taken on board, your talent recognized and achievements rewarded.

So if you want to achieve more in your career, get together with Shell. You can make your online application right now – just visit our career website.

Shell is an Equal Opportunity Employer

[www.shell.com/careers](http://www.shell.com/careers)

Explore it

There's a wider world out there



Achieving more together





# EGR 100

9:00 – Noon  
Second Floor  
Ballroom

## DESIGN OF PRODUCTS FOR COLLEGE DORM ROOMS

**INSTRUCTIONAL TEAM:** Dr. David Grummon,  
Mr. Timothy Hinds, Dr. Bradley Marks, Dr. Susan Masten,  
Dr. George Stockman, Dr. Xiaobo Tan, Dr. S. Patrick Walton,  
Dr. Thomas Wolff

**TA STAFF:** Nicholas Brake, Aaron Greiner, Ki Yong Kwon, Rebecca  
Larson, Michael Murphy, Adam Rogensues, Emily Wandell

**UNDERGRADUATE MENTORS:** Andy Beverly, Amy Bittinger,  
Stephanie Bonner, Wouter Brink, David Cain, Roy Dong, Michael  
Douglass, Eric Ford, Nate Geib, Jamie Jacobs, Sri Kumar, Tracey  
Lynch, Stephan Maxe, Mike McPhail, Allison Mills, John Murphy,  
Michael Opperman, Eric Otte, Jason Provines, Patrick Triscari

### PROBLEM STATEMENT

EGR 100 is a new, college-level course being taken by all incoming engineering freshmen starting this semester. It is an integral part of the Cornerstone Experience / Spartan Engineering program. The course introduces students to the engineering profession and the engineering design process through team-based, interdisciplinary design projects and assignments. Over 450 students are enrolled in EGR 100 this semester.

The final course project had teams of EGR 100 students design a new device or product with a retail cost of less than \$50 to be used in a dorm room by US college freshmen. The teams built prototypes of their products not exceeding a total material cost of \$20. The teams will display their prototypes at Design Day along with posters detailing their product designs. Pre-college students will recognize the most outstanding projects with awards.



## PROTOTYPES OF INNOVATIVE MACHINES AND MECHANISMS

**INSTRUCTOR:** Professor Brian Thompson

### PROBLEM STATEMENT

Teams of 2–4 students were required to design and manufacture simple mechanisms comprised of four-bar linkages, cams and gears that would fit inside a 2'x2'x2' space to accomplish repetitive tasks selected by each team. These mechanical systems are displayed in conjunction with a poster where students demonstrate their prototypes. Pre-college students will select the best designs by interviewing the ME 371 students. Subsequently, the winning team will be presented with the *Sparty Plaque* that was designed and built by students at Holt Junior High School.

### Teams and members

<b>Team 1</b> Michael Douglass Joao Goncalves David Shrock Eric Tauzer	<b>Team 2</b> Meredith Ballard Brittany Haberstroh	<b>Team 3</b> Raghav Nanda Thomas Qualman Brandon Uhl	<b>Team 4</b> Ryan Emmorey Bradley Legris Justin Meeder Daniel Rabideau
<b>Team 5</b> Kyle Scicluna Brian Warner Ross Weaver Matthew Weir	<b>Team 6</b> Dae Chun David Lantzy Benjamin Lindstrom Joseph Marotta	<b>Team 7</b> David Goshgarian Ankita Patel Florian Pribadi Syed Saleem	<b>Team 8</b> Eric Ford Clarence Huff Matthew Owens Jacob Sprague
<b>Team 9</b> Mohanad Bahshwan Charles Baird Neil Ferguson Nicholas Schock	<b>Team 10</b> Harold Black Jared Dorvinen Mitchell Lee Mathieu Rich Case Vandekieboom	<b>Team 11</b> Brandon Kelly John Stukel Samuel Tkac Jeremy Zalud	<b>Team 12</b> Elizabeth Carroll James Guitar Marshall Mendoza Fernando Oliveira
<b>Team 13</b> Timothy Aspinall Derek Baker Amy Bittinger Caitlin Hojnacki	<b>Team 14</b> Stephanie Bonner Nathaniel Davis Michael Karoub Eric McElmurry		



# ME 371

9:00 – Noon  
Second Floor  
Gold A & B

# ME 412

8:50 – Noon  
Second Floor  
Parlor A



## SOLAR HOT AIR BALLOON

**INSTRUCTOR:** Dr. Laura J. Genik

**TA STAFF:** Alan Katz, Anirban Lahiri, Jin Zhang Tam, Andrew White

### Special thanks to Matt Brzezinski, ME 412 Lab Manager

The possibility of flight has always been fascinating and is of great practical importance. The creation of a flying device powered only by sunlight would be very useful but there must be little cloud cover and plenty of sunlight. Joseph and Jacques-Étienne Montgolfière in 1783 France began using buoyancy forces in a hot air balloon to fly. And the Montgolfière was born. The ability of the Montgolfière to stay aloft depended greatly on the temperature of the air within the balloon, which reduced its usefulness for other than recreational purposes. More recently, March 1999, Bertran Piccard of Switzerland and Brian Jones of Britain circumnavigated the globe in a non-stop flight in a hot air balloon. Balloons are not very effective flying devices but they are useful to lift a payload that requires little control/guidance high in to the atmosphere (e.g. weather balloons). Such balloons often use an inert gas to become buoyant. Very recent successful flights have been made with solar Montgolfiere balloons. Such balloons are for very high altitude (longest flight 69 days). They might be used on Mars by NASA.

### PROBLEM STATEMENT

The project team is to design, analyze, build, and test a hot air balloon that will float with the assistance of sunlight only (or an equivalent source). The device will begin at room temperature and there are no restrictions on size. The objective will be to maximize the weight of a payload that can be lifted by the balloon, as well as to minimize the time to become airborne. The team will predict the time to lift as part of the competition. A device must be manufactured by the project team. To test the device, infrared lamps that provide approximately 300 W will be used. The lamps must not be placed any closer than 45cm to any part of the balloon.

TIME	STATION	DESIGN TEAM
8:50 am	A	Patrick Hammer, Joshua Kowalski, Fadi Yousif
8:50 am	B	Jacob Kloss, Lauren Sharp, Christopher Sweeney
8:50 am	C	Zachary McIntyre, Scott Slingerland, Kipp Wallace
9:10 am	A	Justin Bauer, Anthony Carlo, Emily Duszynski, Tyler Grab
9:10 am	B	Nicole Arnold, Shaheen Shidfar, Kevin Wright
9:10 am	C	Tony Davis, Allen Eyler, Raghav Nanda
9:40 am	A	Kevin Derrick, Sergey Korobov, Drew Mosner, Brent Rowland
9:40 am	B	Justin Milburn, Sara Murawa, Brandon Quaranto
9:40 am	C	Bradley Rutledge, Zachary Steffes, Ryan Stull
10:00 am	A	Adam Alderman, Adam Smith, Richard Wahl
10:00 am	B	Matthew Berger, Ryan Boak, Michael Priebe
10:00 am	C	Andrew Gryczan, Joshua Heyden, Richard Hollern
10:20 am	A	Jeffrey Elberling, Kyle Elliott, Brian Steffes
10:20 am	B	William Hurles, Brian Kunkel, Bryce Thelen
10:20 am	C	Timothy Francisco, Luan Huynh, Shangyun Shi
10:40 am	A	Logan Beam, Michael Maurer
10:40 am	B	Eric Jackson, Robert Morris, Eric Tingwall
10:40 am	C	Christopher Meyers, Christopher Miller, Daniel Raphael

# ME 456

9:10 – 11:30  
Third Floor  
Lake Ontario Room



## PROTOTYPES OF COMMERCIAL PRODUCTS

**INSTRUCTOR:** Professor Clark Radcliffe

**TA Staff:** Kyle Szykiel

### PROBLEM STATEMENT

The students in this course were challenged to develop, test, and demonstrate an innovative design for a commercial product that synthesized mechanical, electrical and fluidic components plus imbedded microcontrollers. Typical applications range from automotive engine controls and robotic manufacturing systems to toys and consumer appliances such as microwave ovens. Each group will make a 15-minute presentation and demonstration of a working prototype of their product.

### Mechatronics Systems Design

TEAM	TIME	MEMBERS
Team 1	9:10	Ryan Kelly, Alexander Kerstein, Michael Maurer, Nicholas Schock
Team 2	9:30	Logan Beam, Zachary McIntyre, Kelly Peterson, Bryce Thelen
Team 3	9:50	Ryan Blake, Thomas Theisen, Andrea Vivian, Matthew Wolf
Team 4	10:10	David Cain, Kevin Derrick, Jonathan Luckhardt, Xiaojian Yang
Team 5	10:30	Paul Allen, Feng-Min Chang, Justin Milburn, Ryan Wood
Team 6	10:50	Carl Coppola, Brandon Quaranto, Cody Squibb, Kevin Wright
Team 7	11:10	Drew Darling, Kevin McPhail, Sara Murawa, Zachary Steffes

# Summarized Descriptions of the Four Senior Capstone Courses

2008 Fall Semester

## CE 495 Senior Design in Civil Engineering

*Professor Roger Wallace*

All undergraduates pursuing BS degrees in civil engineering must take CE 495. This course prepares students for the work place by providing a team based, transitional capstone experience with many challenges that civil engineers face in the design/consult business:

- Participation in an engineering project with multiple issues that must be resolved using knowledge from six specialty areas of civil engineering;
- Formulation of specific conceptual solutions to the issues and resolution of conflicting design elements in the project;
- Development of preliminary plans that comply with government regulations and standards, and provide a basis for initial cost estimates;
- Assuming individual responsibility in a team based effort;
- Preparation of written reports for technical and non-technical audiences; and preparation of oral presentations.

Engineers and scientists from the following Michigan firms currently donate their time to provide students with the perspective of practicing professionals: Bergmann Associates; DLZ Corporation; Fishbeck, Thompson, Carr & Huber; NTH Consultants; Soil & Materials Engineers; STS Consultants; Tetra Tech MPS; URS Corporation; and Wilcox Professional Services. We gratefully acknowledge their generous contribution.

## CSE 498 Collaborative Design

*Professor Wayne Dyksen*

CSE 498, Collaborative Design, provides the educational capstone experience for all students majoring in computer science. The course objectives include the following:

- Learning to architect, develop, and deliver a comprehensive software system to a client;
- Learning to work effectively in a team environment;
- Developing written and oral communication skills;
- Becoming proficient with software development tools and environments;
- Learning about system building and system administration; and
- Considering issues of professionalism and ethics.

Corporate clients are local, regional, and national, including Accident Fund, Auto-Owners Insurance, Boeing, Chrysler, Ford, GM, IBM, Microsoft, Motorola, Sircon, TechSmith, the Toro Company and the Union Pacific Railroad.

## ECE 480 Senior Capstone Design

*Professor Erik Goodman*

ECE 480 is required of all electrical engineering or computer engineering majors at MSU.

It prepares students for the workplace, or for graduate school, including:

- Putting into practice the technical skills learned in the classroom, on industrially sponsored team projects, under faculty guidance, doing open-ended design, giving them experience in teamwork, project management, product life cycle management, legal, intellectual property and accommodation issues, and in entrepreneurship.
- Polishing their communication skills – individual and team – on proposals, reports, resumes, evaluations, posters, web pages, and oral presentations.
- Requiring each student to complete four individual hardware/software laboratory assignments.

Team sponsors are local and national, including Chrysler Foundation, General Motors, Genie (Terex Corporation), KELD LLC, Lenovo, Marathon Oil, MSU Biogeochemical Environmental Science Initiative, MSU Resource Center for Persons with Disabilities (Wochholz Endowment), Norfolk Southern, P.I. Engineering, US Naval Research Laboratory, Whirlpool.

## ME 481 Mechanical Engineering Design Projects

*Professor Craig Somerton*

ME481 is required for all mechanical engineering majors at MSU. The course provides students with a team-based capstone design experience:

- Using the technical expertise, communication skills, and teaming methodologies they have learned throughout their mechanical engineering curriculum, along with their creativity, to solve real world problems.
- Collaborating with practicing engineers to address problems sponsored by industry.
- Developing new products or re-designing existing products to reduce costs or enhance reliability.
- Interacting with large, medium-sized, and small companies involved in orthodontic devices, furniture, aerospace structures, automotive parts, consumer

electronics, materials recycling, food processing, and machine tools.

Other projects are humanitarian based, in which the students work with individuals who have special challenges.

Project sponsors include Chrysler Foundation, Dow Chemical Company, Eaton Corporation, General Motors, Lear Corporation, Motorola, Motorola Foundation, MSU Biogeochemistry Environmental Research Initiative, MSU Kellogg Biological Station, Nissan Technical Center North America, P.I. Engineering, Shell Oil Company, and Terex Corporation

# DENSO

## Visionary Engineering + Valued Partnerships

A leading global supplier to the automotive industry, DENSO delivers advanced technology, systems and components that maximize vehicle safety and minimize the environmental impact of automobiles.

In North America, we have 33 facilities with more than 16,000 employees to support our customers.

Driven by excellence, DENSO manufactures a wide range of products including HVAC units, fuel pumps, power window motors, airbag sensors, starters and alternators.

Visit us online at [www.denso-corp-na.com](http://www.denso-corp-na.com)



Wiper Systems



Diesel Common Rail



Powertrain Control Systems

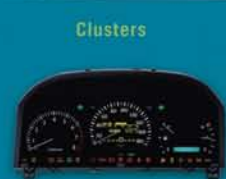

Clusters

Instrument & Display



HVAC Units

Thermal Systems



Adaptive Cruise Control

Driving Control & Safety

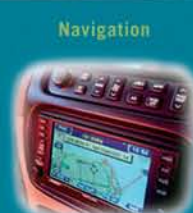

Navigation

ITS/Navigation

THURSDAY: 8:00 A.M. - 1:00 P.M. 2ND FLOOR CONCOURSE

FRIDAY: 8:00 A.M. - 1:00 P.M. BILLIARD ROOM

"Design, Build, Listen, Change...  
Your World!"

## Audio Enthusiasts and Engineers

In the Fall of 2006 a small group of like-minded engineers turned their dreams into reality by founding Audio Enthusiasts and Engineers, an organization open to all Michigan State University students. AEE hit the ground running its first semester by designing and building their first masterpiece 'Revolution Audio', a stereo system engineered to produce true stereo sound regardless of which direction the listener is facing. AEE quickly became the means for students passionate about audio to get together and turn ideas into realities. Five semesters later, the group has evolved into an independent, student run, project oriented organization accomplishing amazing things in remarkable amounts of time.

AEE consists of students from various backgrounds including almost every engineering discipline as well as telecommunications, business, psychology, and many others in between. The common trait bringing all these creative minds together is a love for audio. AEE members have represented Michigan State University at the following national Audio Engineering Society conventions:

121st, San Francisco, CA, USA - October 5-8, 2006

123rd, New York, NY, USA - October 5-8, 2007

124th, Amsterdam, The Netherlands - May 17-20, 2008

125th, San Francisco, CA, USA - October 2-5, 2008

AEE has become one of the most active student organizations in the College of Engineering. Its members are devoted to expanding the understanding of audio concepts, as well as finding inventive ways to implement this knowledge. This is the fifth consecutive Design Day since their inaugural semester showcasing their work and accomplishments.

AEE would like to thank our Sponsors:

- ADVANCED CIRCUITS
- BOURNS
- CIRRUS LOGIC
- DH LABS
- ELECTRONIC INTERCONNECT
- LINEAR SYSTEMS
- NEUTRIK
- PENNY AND GILES

Without the help of our sponsors we would not have the ability to turn our dreams into realities. If you would like to help please contact us.  
[aeemsu@gmail.com](mailto:aeemsu@gmail.com)



"AEE Teamwork"  
Photo by: Jakub (Kuba) Mazur

Faculty Advisor  
Dr. Gregory Wierzba

### Officers

Eric Tarkleson    Jakub Mazur  
President            Vice President

Mike Varney        Rachel Bouserhal  
Treasurer            Secretary

### This Semester's Team Leaders

Brandon Boozer - Amplifier  
Rachel Bouserhal - Tube Amplifier  
Jakub Mazur - CSE/Programming  
Matthew Naughton - Fix It  
Christa Pline - Events/Sponsors  
Shreyas Thiagaraj - Speakers  
Michael Varney - Audio Forum

[www.aeemsu.com](http://www.aeemsu.com)



## COMPUTER SCIENCE AND ENGINEERING DESIGN PROJECTS

### PRESENTATION SCHEDULE – Lake Erie Room

Prof. Wayne Dyksen

Time	Company	Project Title
8:00 CSE 498	Auto-Owners Insurance Company	Recruiting Contacts and Events System
8:25 CSE 498	The Boeing Company	KML Urban Scene Builder 2008
8:50 CSE 498	Chrysler, LLC	Performance Feedback System Dashboard
9:15 CSE 498	Ford Motor Company	Ford Test Drive
9:40–10:00 Break		
10:00 CSE 498	IBM	Fixpack Publishing Tool Enhancements
10:25 CSE 498	Microsoft	Application Health Monitoring System
10:50 CSE 498	TechSmith Corporation	Cloud Powered Media Searching
11:15 CSE 498	The Toro Company	GolfVision Interface for Turf Guard

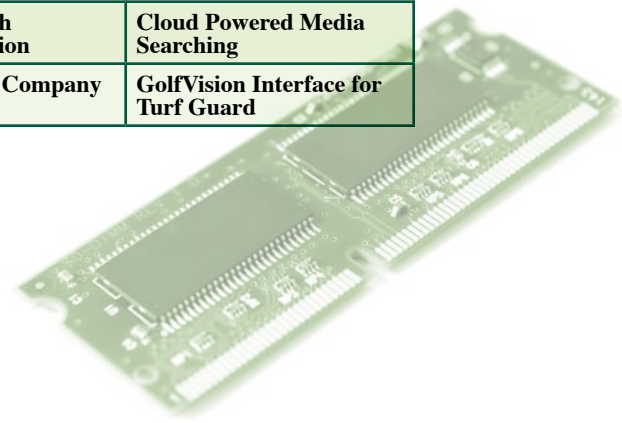

## AUTO-OWNERS INSURANCE COMPANY RECRUITING CONTACTS AND EVENTS SYSTEM

The Auto-Owners Insurance Company attends many job fairs and recruitment drives. They also hold training seminars and other activities within their company. These events are attended by Auto Owners Insurance employees located in various states.

We worked with the personnel department in order to develop a system that tracks these events using a calendar display. This system reports and maintains the events in a database for easy access and adaptability on the Internet.

When a staff member wishes to add an event, they are required to log-in to the system. Once logged in, they can add an event to the calendar which displays the newly created event for the individual on their personal calendar, and simultaneously adds this to a world calendar. This can be viewed by anyone in the company.

Before the event occurs, the user is given a reminder appointment through their company's Microsoft Outlook email. This notification contains contact information, times, a map to the location, along with other pertinent data for the event.

Our application is protected with a user name and password for each individual. There are multiple types of users, each having their own restrictions. Some users can only view the calendar, while other users will have full access to the application.

The software is written in C# using ASP.NET, with a Microsoft SQL Server database.

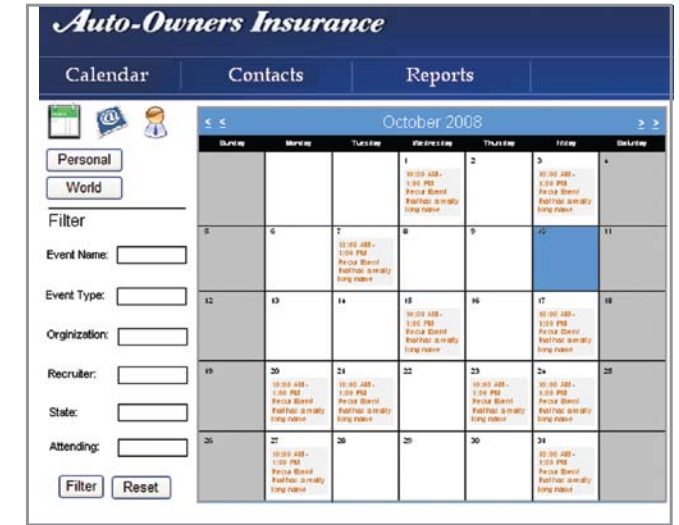

**Michigan State University**  
*Team Members* (left to right)

Tom Randall  
East Lansing, Michigan

Mike Korynski  
Troy, Michigan

Ashleigh New  
Okemos, Michigan

Jonathan Lindsey  
Lakeview, Michigan

**Auto-Owners Insurance**  
*Corporate Sponsors*

Lateresa Baker  
Lansing, Michigan

Bob Buchanan  
Lansing, Michigan

Heidi Dowling  
Lansing, Michigan

Mark Hempsted  
Lansing, Michigan

Scott Lake  
Lansing, Michigan

Fern Shaffer  
Lansing, Michigan

## THE BOEING COMPANY KML URBAN SCENE BUILDER 2008

With increasing challenges to our military from counter-insurgent combat and intelligence gathering situations comes the need to build realistic scenes of urban environments similar to those used in computer games. The KML Urban Scene Builder enables users to build such 3D urban environments quickly and easily.

Using a custom extension to Google Earth, users first trace an outline of the exterior walls of buildings. Next they provide a small number of features about each building. The KML Urban Scene Builder then automatically generates a 3D model approximating each building's shape and look. Scenery for large urban areas can be generated easily and quickly.

In order for the scenery to be as realistic as possible, a user must provide a minimal amount of information about each building. For example, a user might specify that a building is an apartment building, an office building, or a mall. A user can also specify the height of each building to ensure that the 3D aspect of the scene is realistic.

After all the information has been defined by a user, the KML Urban Scene Builder chooses models that will best portray each building. Once the urban 3D scenery has been generated, a user can view it using Google Earth.

The KML Urban Scene Builder builds 3D urban environments using a combination of the Google Earth interface, KML 2.2, and the Lua scripting language. KML is based on XML, using a tag-based structure with nested elements and attributes.

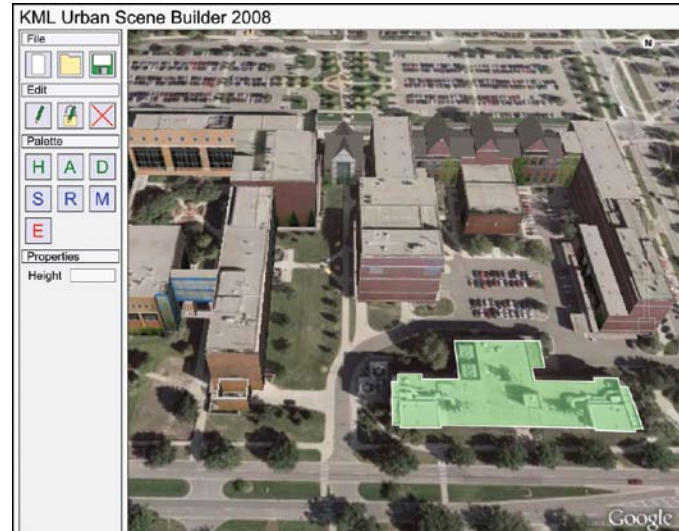

## CHRYSLER, LLC PERFORMANCE FEEDBACK SYSTEM DASHBOARD

The Performance Feedback System, or PFS, is the method Chrysler uses to track the status of cars in each of their assembly plants. There are hundreds of sensors and tools throughout each assembly plant that report manufacturing problems and statistics to the PFS database. This information is then used by Chrysler technicians to fix a problem before the car is sold, and by managers to monitor the status of a certain area or car on the plant floor.

The current way that employees get information from the Performance Feedback System is through a website that allows them to create a graph of the data they need.

However, if an employee would like to see multiple areas of the plant, or multiple views of an area, he/she must manually create each type of graph needed. Additionally, if the employee needs to see the same types of graphs every day, they must create them each time. This is where the PFS Dashboard system comes into play.

The PFS Dashboard is a website that can display many graphs of real-time information at the same time, and allow the employee to arrange and customize each as desired. In addition, they can choose a personalized set of graphs to view for their specific area of interest, and save it for next time they log-in for quick access.

The PFS Dashboard is powered by Java2, Java Server Pages, JavaScript, and a MySQL database.

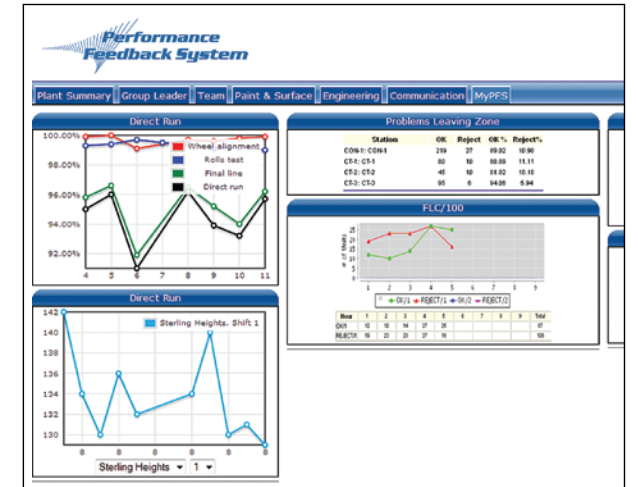

**Michigan State University**  
Team Members (left to right)

- Jeff Winship  
Brighton, Michigan
- Tom Pytleski  
Bakersfield, California
- Michael Jeffery  
Troy, Michigan
- Daniel Briggs  
Grand Ledge, Michigan

**The Boeing Company**  
Corporate Sponsors

- Jonathon Marjamaa  
St. Louis, Missouri
- Lorne Mitchell  
St. Louis, Missouri
- Jayson Vincent  
St. Louis, Missouri
- Michael Williams  
St. Louis, Missouri



**Michigan State University**  
Team Members (left to right)

- Meshal Alsahli  
Khafji, Saudi Arabia
- David Ackerman  
Buchanan, Michigan
- Julian Simioni  
Troy, Michigan
- Taylor Marshall  
Flint, Michigan

**Chrysler, LLC**  
Corporate Sponsors

- David Bonskey  
Auburn Hills, Michigan
- Karen Wrobel  
Auburn Hills, Michigan
- Paul Van Hese  
Auburn Hills, Michigan
- Hayward Little  
Auburn Hills, Michigan

## FORD MOTOR COMPANY FORD TEST DRIVE

The Ford Test Drive project seeks to use technology to improve the customer's experience at a Ford dealership, and to provide Ford with information the company can use to build vehicles that customers want to purchase.

Small sensors are placed in each test drive vehicle at the Ford dealership. These sensors create and maintain a wireless mesh network, which allows them to communicate with other nodes in the network and the base station within the dealership.

When a vehicle is taken for a test drive, the sensors collect data on the customer's driving habits and preferences, including accelerometer data and even the interior temperature the customer prefers.

Upon returning from a test drive, this data is sent wirelessly over the mesh network to the base station, which transfers this information to a computer. The computer analyzes the data and stores it in a database.

This data can then be accessed by Ford dealership employees via a web portal. Visual aids like graphs and charts allow the dealership employees to quickly highlight customer driving tendencies. This allows them to provide specific feedback to the customer about what vehicle would best suit their driving style. The Ford Test Drive project also provides Ford with information about seasonal or yearly changes in test vehicle popularity and other data Ford can use to gauge the popularity of specific models.

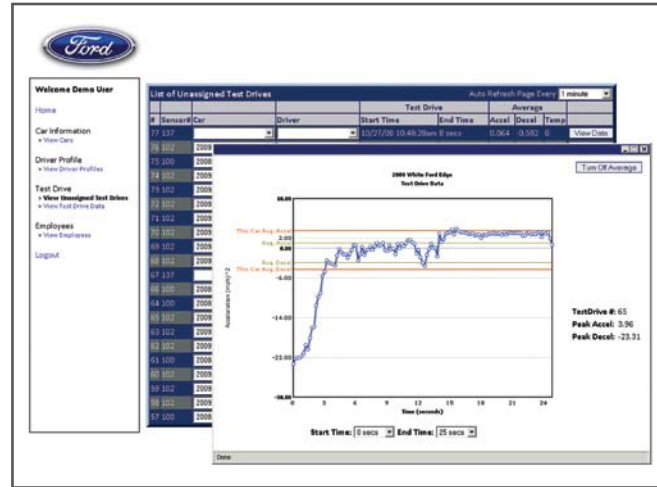

## IBM FIXPACK PUBLISHING TOOL ENHANCEMENTS

When a software company releases a product, the "original" release is often not the "final" release. Later companies provide upgrades to fix bugs, add functionality, etc. At IBM, these updates come in the form of FixPacks.

FixPacks are collections of updates for multiple products and platforms. As a result, these updates tend to be very large in size, typically multiple gigabytes per update.

Before a customer can retrieve an update, IBM must publish the fixes to a centralized repository so they will be available to their customers. Users of this tool typically publish between 30 to 50 FixPacks in a single session and, due to the size of the FixPacks, this can be time consuming.

The FixPack Publishing Tool aims to semi-automate this process by allowing IBM employees to publish fixes in bulk, as well as to reduce the amount of work required to publish a Fix. This tool does this by allowing employees to choose multiple FixPacks, modify any data associated with them, and publish them in bulk as opposed to individually. Another way in which this tool reduces the amount of work required to publish fixes is by eliminating the need for users to repeatedly re-enter information that, for the most part, is reusable.

The FixPack Publishing Tool will be integrated into Eclipse, a programming environment developed by IBM, and will run on both Microsoft Windows and Linux. IBM users familiar with Eclipse will find this plug-in easy to use as either a stand-alone tool, or along with other Eclipse plug-ins.

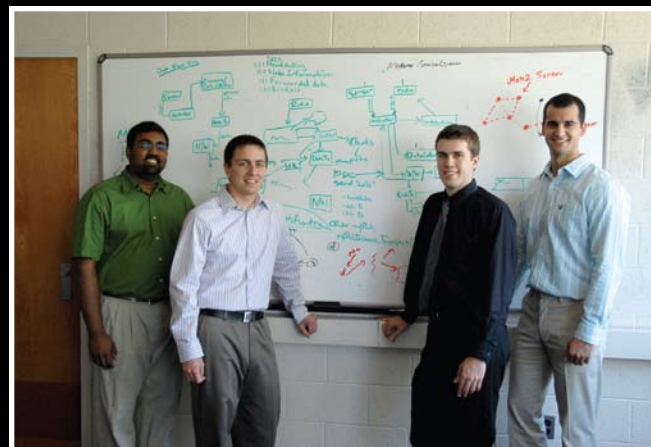
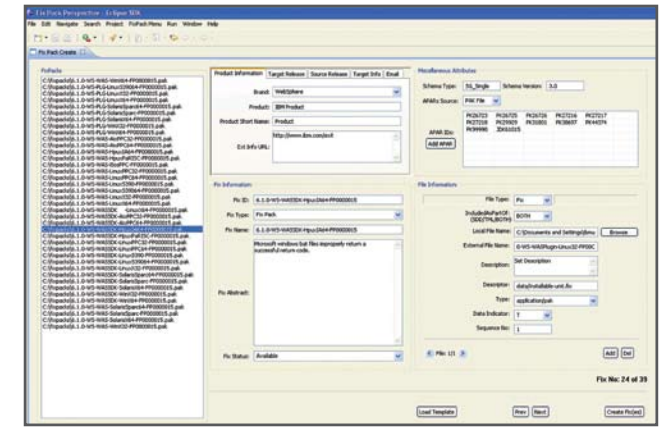

**Michigan State University**  
Team Members (left to right)

- Jeffrey Ignatius  
Okemos, Michigan
- Ronald Rodriguez  
Port Huron, Michigan
- Ryan Wagoner  
Three Rivers, Michigan
- Stephen Rice  
East Lansing, Michigan

**Ford Motor Company**  
Corporate Sponsors

- Michael Volk  
Dearborn, Michigan
- Matthew Whitaker  
Dearborn, Michigan

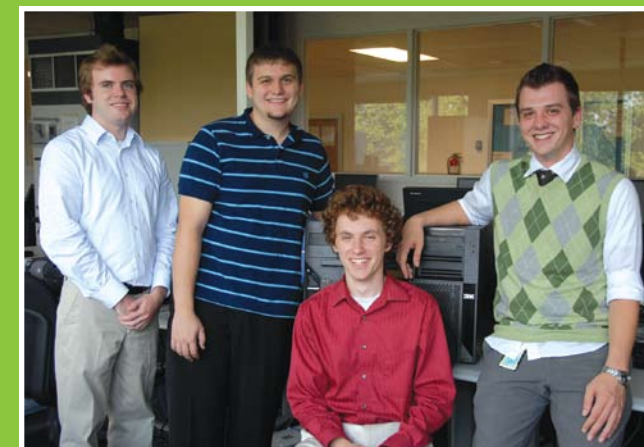

**Michigan State University**  
Team Members (left to right)

- Michael Haine  
Midland, Michigan
- Tom Castellani  
Clinton Township, Michigan
- Richard Schultz  
Mason, Michigan
- Andrew Daniels  
Lansing, Michigan

**IBM**  
Corporate Sponsors

- Brad Topol  
Raleigh, North Carolina
- Duane Kirkland  
Rochester, Minnesota
- Carolyn Norton  
Ann Arbor, Michigan

## MICROSOFT APPLICATION HEALTH MONITORING SYSTEM

Information Technology operators for Microsoft products currently lack the means to monitor and track the health of their applications running on their servers.

Often these applications were written by someone other than the IT Operator and as such they do not have the intricate technical knowledge of the application. This poses a problem when they need to analyze lower level components of the application, such as variables, events and exceptions.

One such example would be a web application for ordering pizzas from a pizzeria. If the owner of the pizzeria would like to track the number of orders placed and view the data over time, he may have a hard time doing so.

To solve this problem the owner could utilize our application health monitoring system. This would enable the owner to view pizza order tracking data in real time and view trends.

The application health monitoring system we have developed provides IT operators with the feedback they need about how their server applications are operating in real time. They can then use this information to determine the health of the applications they oversee.

Unlike troubleshooting, the health monitor is proactive; this allows operators to notice trends before an actual failure occurs. This will also help provide an entry point to troubleshooting an application.

The web interface of this system is composed of web parts on a Windows SharePoint site. Most of the development was done with C# and Silverlight technologies.



**Michigan State University**  
Team Members (left to right)

- Mathew Mason  
Roseville, Michigan
- Chris Monosmith  
Grand Blanc, Michigan
- Tom Alexander  
Chesterfield, Michigan
- Bruno Summer  
Roseville, Michigan
- Andrew Keller  
Grand Rapids, Michigan

**Microsoft**  
Corporate Sponsors

- Shailesh Saini  
Redmond, Washington
- Maciej Skierkowski  
Redmond, Washington



## TECHSMITH CORPORATION CLOUD POWERED MEDIA SEARCHING

Imagine receiving a video that contains the recording of a PowerPoint school lecture or business meeting that is over an hour long. You sat through the presentation and remember something interesting on a PowerPoint slide that you wanted to reference. Normally you would re-watch the video to find the relevant section of text. This can be a very time consuming process. With Cloud Powered Media Searching you can efficiently and effectively find the positions in the video by providing search terms.

At the core of the Cloud Powered Media Searching is a service that actually processes the video. The service is an application running on a server that takes in an image or video and returns a list of terms along with their corresponding time and location on the screen.

SEEC, a website very similar to YouTube, allows users to upload videos to be displayed on the site. Users can then search all of the videos on SEEC for terms that may exist on the screen of video. The user can also search for terms within an individual video by providing a keyword. A list of results is displayed, showing the times in the video where the term was found. Clicking the result will take the user to that specific point in the video. SEEC uses the Cloud Powered Media Search service to process the video and obtain words that users can employ in their search.

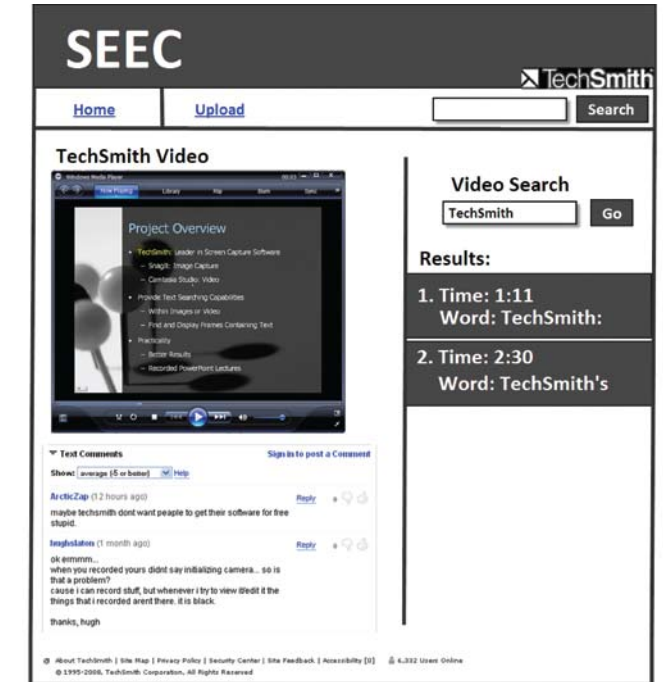

**Michigan State University**  
Team Members (left to right)

- Derek Gebhard  
Howell, Michigan
- Scott Lamparski  
Algonac, Michigan
- Caitlin Nelson  
East Lansing, Michigan
- Keith Barber  
Grand Ledge, Michigan

**TechSmith Corporation**  
Corporate Sponsors

- Dean Craven  
Okemos, Michigan
- Randy Schott  
Okemos, Michigan
- Michael Malinak  
Okemos, Michigan





## THE TORO COMPANY GOLF VISION INTERFACE FOR TURF GUARD

Golf course management is a multi-million dollar per year industry. Only course managers with the right soil data can make the right choices to maintain pristine conditions for maximum playability. To respond to this need, the Toro Company developed the cutting edge Toro Turf Guard Wireless Soil Monitoring System.

The Toro Turf Guard Wireless Soil Monitoring System consists of buried sensors, repeaters, a base station, and a user interface. The sensors transmit data on soil moisture, temperature, and salt levels every 5 minutes around the clock. The existing web-based Golf Vision user interface for Turf Guard is beginning to show its age. Toro wanted a faster and more intuitive Golf Vision desktop application that golf course managers can use to monitor course conditions accurately.

The new Golf Vision user interface provides access to data acquired from the existing Turf Guard system and presents it to course managers in an intuitive way, with easy to read graphs via the Dundas Charting Library. The interface provides quick summaries of soil moisture, salinity, and temperature, while also allowing users to drill down into more detailed information.

Weather forecasts coupled with the Turf Guard data, provide valuable information that allows course managers to make immediate decisions for present and future conditions.

Golf Vision was developed using Microsoft's .NET Framework, and is written in C#.

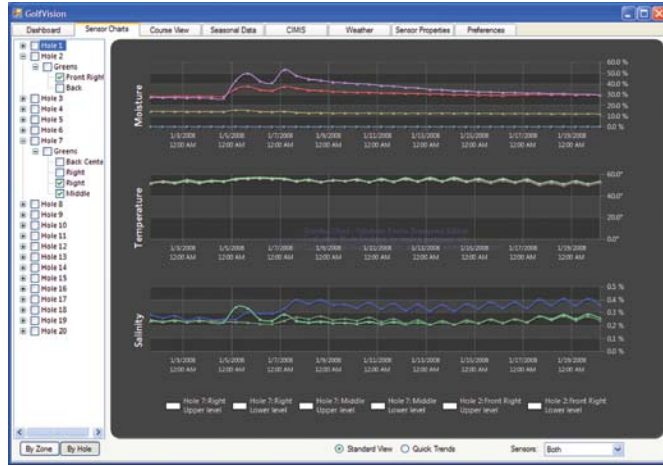

### Michigan State University Team Members (left to right)

- Jacob Denzer  
Brighton, Michigan
- Brian Walsh  
Okemos, Michigan
- Brett Lesnau  
Clinton Township, Michigan
- Eric Jensen  
Kalamazoo, Michigan

### The TORO Company Corporate Sponsors

- Joseph Chang  
Riverside, California
- Nathan Fujimoto  
Riverside, California
- Jason Hill  
Riverside, California
- Rick McClure  
Riverside, California

# thank YOU

### Computer Science Sponsors...

We thank the following companies for their generous support of the Department of Computer Science and Engineering and our senior capstone course lab:

Auto-Owners Insurance Company  
Lansing, Michigan



Chrysler LLC  
Auburn Hills, Michigan



Crowe Horwath LLP  
Oak Brook, Illinois



IBM Corporation  
Rochester, Minnesota



Sircon  
Okemos, Michigan



TechSmith Corporation  
Okemos, Michigan



## ELECTRICAL AND COMPUTER ENGINEERING AND MECHANICAL ENGINEERING PROJECTS

PRESENTATION SCHEDULE — Lake Huron Room

Course Coordinators: Professors Erik Goodman and Craig W. Somerton

Faculty Advisors: Professors Aviyente, Ayres, Deller, Gokcek, Patterson, Peng, Shaw, Somerton, Zhu

Time	Project Sponsor(s)	Sponsor Contact(s)	Faculty Advisor(s)	Project Title
8:00 ECE 480	Whirlpool Corporation	R. Jeffery C. Moes	S. Aviyente	Barcode Cooking "GPS"
8:25 ECE 480	Norfolk Southern	K. Conn	V. Ayres	Trackside System Sensing/Responding to Changing Conditions
8:50 ME 481/ ECE 480	P.I. Engineering	M. Hetherington	C. Gokcek G. Zhu	Quasi-Motion Ship Simulator
9:40–10:00 Break				
10:00 ECE 480	General Motors	A. Gellatly	D. Deller	Early Emergency Signal Detection Sound Processing Unit
10:25 ECE 480	Keld, LLC	R. Koenig	F. Peng	Battery-Supercapacitor Hybrid Energy Storage System
10:50 ME 481	Shell Oil	C. Robins	S. Shaw	A School Supplies Carrier for McKenzie Robins
11:15 ME 481	Motorola	J. Wojack	E. Patterson	Keypad-enabled Product Design for a Mobile Device
11:40 ME 481	WoodCreek Magnet Elementary School & Motorola & MSU	D. Graham S. Raymer	C. Somerton	Thermal Solar Collector Demonstrator For Woodcreek Elementary School
12:05 ME 481	Lear Corporation & Chrysler Foundation & The Appropriate Technology Collaborative	J. Barrie	C. Somerton	A Vaccine Refrigerator for Remote Regions with the Appropriate Technology Design Collaborative

## WHIRLPOOL CORPORATION: BARCODE COOKING "GPS"

Whirlpool is sponsoring our project to improve the already existing technology of a microwave oven with a barcode reader. Our team's objective is to design an efficient barcode reader as a separate accessory for all series of Whirlpool's microwave ovens. Instead of scanning the Universal Product Code printed on food packages, Whirlpool will team up with food companies to print another barcode on the food products' packages. We will design the additional barcode to contain the directions necessary for cooking the food, such as time, power level and instructions for display to the users. The food ready to be cooked is simply scanned and placed inside the microwave oven. The barcode reader then sends the barcode as a serial string to the processor. The processor decodes the string and sends the cooking instructions to the microwave oven. Once the start button is pressed, the food will cook at the correct power level for the correct amount of time. The microwave will have a display screen to display times and other instructions typed on the food package, such as 'stir the vegetables.' The barcode reader module adds convenience to the microwave by eliminating manual user input and the need to keep track of the instructions on a food package. To allow for easy expandability and versatility, the reader will be a separate module from the microwave and sold as an add-on.

<http://www.egr.msu.edu/classes/ece480/goodman/fall08/group06/>

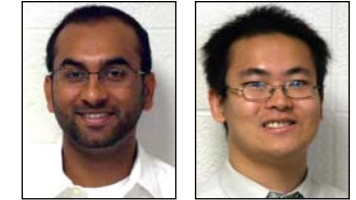

V. Mukkamalla  
Electrical Eng

S. L. Chan  
Electrical Eng



S. Mansour  
Electrical Eng

C. Palm  
Electrical Eng



Mr. Jeffery



Mr. Moes

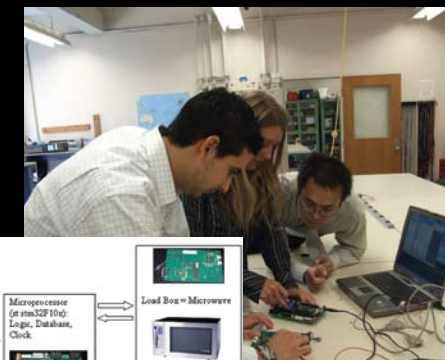

Prof. Aviyente

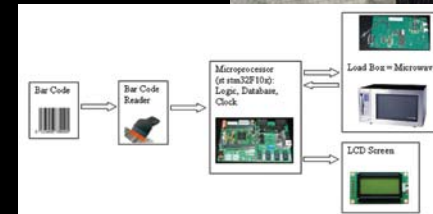

**Project Sponsor**  
Whirlpool Corporation

**Sponsor Representatives**  
Mr. Randy Jeffery  
Mr. Chris Moes

**Faculty Facilitator**  
Dr. Selin Aviyente

**Team Members Non-Technical Roles**

Vijay Mukkamalla  
Manager

Sui Lee Chan  
Webmaster

Samer Mansour  
Documentation Prep

Christina Palm  
Presentation Prep &  
Lab Coordinator

## NORFOLK SOUTHERN: TRACKSIDE SYSTEM SENSING/ RESPONDING TO CHANGING CONDITIONS

Norfolk Southern Corporation has implemented Wayside Top of Rail (TOR) systems that dispense lubricant onto train tracks in high friction locations, such as tight curves. The system consists of a 100 gallon tank, a pump, and a battery. An external solar panel is positioned in the area to charge the battery for a minimum of four hours per day. The pump currently runs for a quarter of a second for every 12 axles, resulting in 0.13 gallons pumped per 1000 axles. The locations where these systems are installed have an average of 8000 axles per day, but a high standard deviation makes a standard refilling schedule hard to implement. The lubricant inside the tank must not sink below the pump connection because air inside the pump will cause failure and the pump will need to be replaced. A design constraint is that the body of the tank not be pierced by the sensor addition.

The Dual Liquid Electrical Sensing System, using ultrasound and audio cavity modes, will externally monitor the level of lubricant and shut off the pump when it sinks below the tolerance level. The new system must not modify the tank but should be placed in the electronics cabinet, which currently houses the battery and pump. The lubricant has the consistency of latex paint and will solidify if exposed to air for a period of time. The status of the amount of lubricant will therefore be displayed inside the electronics cabinet so the contents will not be exposed. The addition of an external wireless communication system is an extra feature that would provide the convenience of remote monitoring of multiple systems from railway inspection.

<http://www.egr.msu.edu/classes/ece480/goodman/fall08/group08/>



G. P. Ballios  
Electrical Eng M. W. Dow  
Electrical Eng

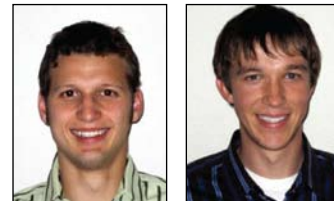

N. T. Vogtmann  
Electrical Eng C. M. Zofchak  
Electrical Eng



## PI ENGINEERING: QUASI-MOTION SHIP SIMULATOR

Our design team has been sponsored by PI Engineering to develop and build a ship simulator. This project will require the combined efforts of computer, electrical, and mechanical engineers to achieve the desired results.

The final product will provide a realistic look and feel of being aboard a ship by utilizing a quasi-motion platform along with realistic controls and a visual display provided by Virtual Sailor simulation software. When completed, the simulator will be capable of being moved to facilitate both being displayed at our Design Day and allowing PI Engineering to transport it to trade shows or other locations as a display of both the hardware and software they can provide.

Our team will divide the work amongst our multiple concentrations so the mechanical engineers will be designing and building the platform and physical control portions while our computer engineers will adapt the current simulation software to allow the use of realistic controls and displays rather than simple mouse and keyboard inputs and monitor displays. The electrical engineers will develop gauges to display the information from the program while also providing the necessary electronics to allow communication between the physical controls and the software.

<http://www.egr.msu.edu/classes/ece480/goodman/fall08/group03/>



B. Witherspoon  
Electrical Eng D. Gobeski  
Mechanical Eng J. King  
Electrical Eng



M. Rogers  
Computer Eng M. Priebe  
Mechanical Eng R. Boak  
Mechanical Eng



R. Wahmhoff  
Computer Eng D. Raphael  
Mechanical Eng



Mr. Conn



Prof. Ayres

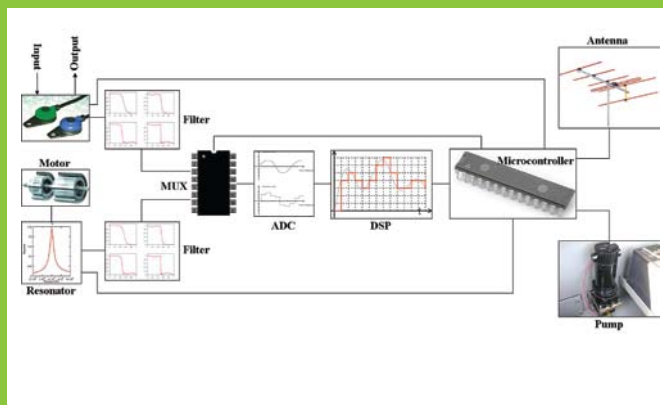

**Project Sponsor**  
Norfolk Southern

**Sponsor Representative**  
Mr. Kevin Conn

**Faculty Facilitator**  
Dr. Virginia M. Ayres

**Team Members Non-Technical Roles**  
Craig M. Zofchak  
Manager

Michael W. Dow  
Webmaster

Nicholas T. Vogtmann  
Documentation Prep

George P. Ballios  
Presentation Prep &  
Lab Coordinator



Dr. Zhu



Dr. Gokcek

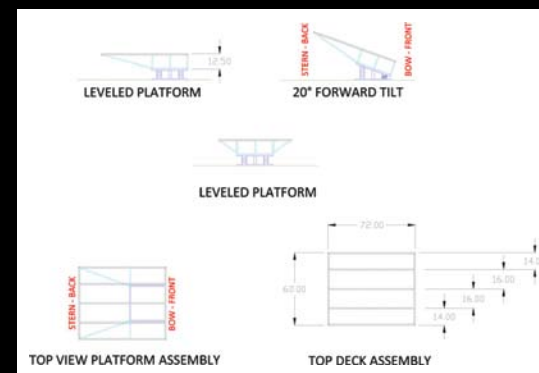

**Project Sponsor**  
P. I. Engineering

**Sponsor Representative**  
Dr. Michael Hetherington

**Faculty Facilitators**  
Prof. George Zhu  
Prof. Cevat Gokcek

**Team Members Non-Technical Roles**  
Justin King  
Manager

Bryan Witherspoon  
Michael Priebe  
Webmasters

Rebecca Wahmhoff  
Daniel Raphael  
Documentation Prep

Mark Rogers  
Doug Gobeski  
Presentation Prep

Mark Rogers  
Ryan Boak  
Lab Coordinators

## GENERAL MOTORS: EARLY EMERGENCY SIGNAL DETECTION SOUND PROCESSING UNIT

Today's typical driver does a variety of things while driving. Modern technology has made it possible to increase productivity, to get navigational assistance, or simply to enjoy the ride a little more. Technology enhancements, however, also create safety risks by diverting driver attention. Further, aging populations in Western nations imply increasing numbers of drivers with diminished sensory abilities and reaction times. These factors run counter to the need for increased driver vigilance as rising populations result in more roadway congestion. Among the many adverse effects of lessened driver attention is the lack of awareness of emergency vehicles in the vicinity, with the resultant hazards to nearby traffic and the impeding of emergency operations.

The goal of this project is to produce a system that will alert the motorist to the presence of emergency vehicles. The system will monitor the acoustic environment and detect emergency signals. Once the siren is detected, the system will perform two important functions. First, the radio will be muted so that it does not prevent the driver from hearing the siren. The system will additionally light an indicator on the dashboard to inform the driver that an emergency situation is in progress.

<http://www.egr.msu.edu/classes/ece480/goodman/fall08/group09>



D. VanderLaan Electrical Eng J. Konz Electrical/Computer



T. Aprik Computer Eng N. Hannon Electrical Eng



## KELD, LLC: BATTERY-SUPERCAPACITOR HYBRID ENERGY STORAGE SYSTEM

Due to the increased demand for alternative energy, research in this field has skyrocketed over the past decade. One solution has been to use rechargeable batteries in conjunction with already existing gas powered systems in order to create a hybrid machine. With hybrid systems, the net amount of energy output in a useful form is greater than in non-hybrid systems. Our sponsor, Roger Koenig of *KELD, LLC*, wanted us to take this solution one step further using electric double-layer capacitors, also known as supercapacitors. Supercapacitors have a higher power density than regular capacitors, giving them the ability to handle large amounts of energy. Also, supercapacitors allow a greater number of charge and discharge cycles (in the millions) and quicker charge times than rechargeable batteries. With a hybrid system incorporating supercapacitors, the cost of replacing batteries and the size and weight of the power plant will all be reduced.

Our design has a Lithium Ion battery providing constant power for 20 minutes and the supercapacitors providing short-term pulse power to a pulsating load. In this system, a microcontroller controls the pulsating energy demand. Our prototype consists of a 48-volt hybrid battery-supercapacitor energy storage system and a programmable, one-kilowatt-peak pulsed load.

<http://www.egr.msu.edu/classes/ece480/goodman/fall08/group10>



M. Mukongolo Electrical Eng C. F. Lo Electrical Eng



J. Adams Electrical Eng M. Kovalcik Electrical Eng



Dr. Deller

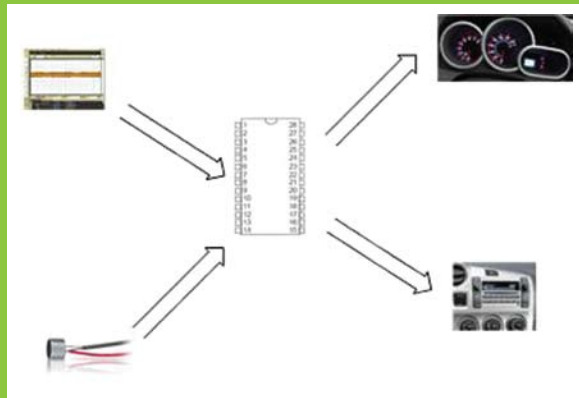

**Project Sponsor**  
General Motors

**Sponsor Representative**  
Dr. Andrew Gellatly

**Faculty Facilitator**  
Dr. Jack Deller

**Team Members**  
**Non-Technical Roles**  
Don VanderLaan  
Manager

Jeremy Konz  
Webmaster

Natalie Hannon  
Documentation Prep

Tom Aprik  
Presentation Prep  
& Lab Coordinator



Dr. Peng



Mr. Koenig

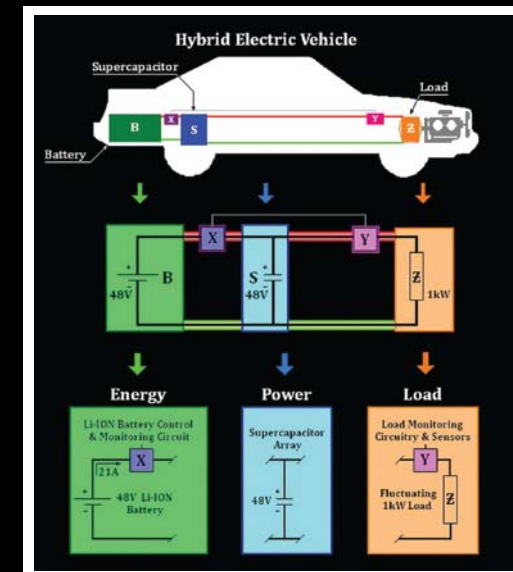

**Project Sponsor**  
KELD, LLC

**Sponsor Representative**  
Mr. Roger Koenig

**Faculty Facilitator**  
Dr. Fang Peng

**Team Members**  
**Non-Technical Roles**  
Marvell Mukongolo  
Manager

Chi-Fai Lo  
Webmaster

Michael Kovalcik  
Documentation Prep

Jamal Adams  
Presentation Prep &  
Lab Coordinator



## A SHELL OIL COMPANY CHILDREN'S HUMANITARIAN PROJECT: A SCHOOL SUPPLIES CARRIER FOR MCKENZIE ROBINS

The Shell Oil Company Children's Humanitarian Project is sponsoring McKenzie Robins in a project to help facilitate her daily life by increasing her mobility and giving her more independence in school.

McKenzie Robins is a very energetic 11-year-old 4th grader. She has cerebral palsy, a tracheostomy, and lung disease with asthma. Due to the medical complications, McKenzie needs the assistance of medical supplies that weigh 25 lbs. In addition, her limited balance makes it difficult for her to carry her supplies and school materials through the crowded hallways of her school.

The objective of this project is to design a carrier that will allow McKenzie to maneuver effectively through her school independently.

Some of the major factors we were faced with in this project were reliability, quality, and adaptability. One requirement of the design was that the product would not necessitate a high level of maintenance. Also, it is essential that McKenzie has her medical supplies available at all times, so it was crucial that the carrier not fail. It also needed to be adaptable to her increasing height as she grows older. In doing so, she could continue to use the carrier through middle school and high school. Additionally, McKenzie's physical therapist thought it would be best for her growth if the carrier were designed such that she could not support her weight on it, allowing her to develop balance without assistance.

... The Shell Oil Company Children's Humanitarian Project Team

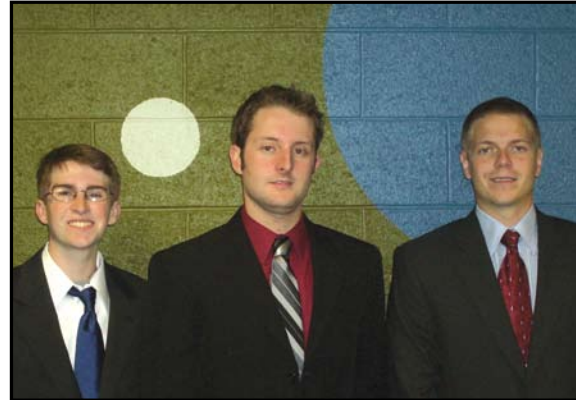

McKenzie Robins

My daughter, McKenzie was born early and has Cerebral Palsy (CP) in her legs, lung disease and asthma, and a tracheostomy. Her tracheostomy supply bag weighs 25 pounds, in addition to her book bag. Also, because of her CP she has balance problems and the hallways of a middle school are crowded. We need a way for her to carry her bag and her books and be safe in the halls. The impact of this project will make her safe and add to her independence.



Prof. Shaw

Cheryl Robins  
McKenzie's Mother

**Project Sponsor**  
Shell Oil Company  
Houston, Texas

**Professional Advisor**  
Ms. Cheryl Robins

**Faculty Advisor**  
Prof. Steven Shaw

**Team Members and Home Towns**  
Kevin Derrick  
Midland, Michigan

Luis Goncalves  
Midland, Michigan

Patrick Hammer  
Livonia, Michigan



## MOTOROLA: KEYPAD-ENABLED PRODUCT DESIGN FOR A MOBILE DEVICE

Motorola is a global communications leader that has been at the forefront of communication inventions and innovations for the past 80 years. With global headquarters based in Schaumburg, Illinois, Motorola employs approximately 66,000 people worldwide. It provides technologies, solutions, and services that make mobile experiences possible. Its products include cellular phones, wireless accessories, and digital entertainment devices. The spirit of invention is what drives Motorola's success.

With the rapid technological convergence of cellular phones, computers, and MP3 devices in today's market, there is a growing consumer demand for the next generation mobile phone. With the high popularity of texting among mobile phones, Motorola is exploring new unique concepts to design and integrate a user friendly QWERTY keypad in a mobile cellular device. A product that will be completely different to any mobile cellular device that is currently on the market.

The goal of this project was to design and fabricate a unique, space efficient, QWERTY keypad that maximizes the effective display area on a mobile phone device while minimizing the product size. Key issues in design were keypad usability and phone thickness. Functional prototypes were built for design review and refinement.

This project fits into Motorola's mindset by breaking through pre-conceived design barriers and exploring new ideas and innovations concerning mobile devices.

...The Motorola Student Design Team



**MOTOROLA**



Mr. Wojack

The development of a new or improved keypad-enabled product aligns with Motorola's ambition to develop compelling mobile devices that allow consumers to be more productive. The goal of this project will be to create a new paradigm for how a keypad-enabled product is designed.

Jason Wojack  
Principal Staff Mechanical Engineer  
Motorola



Prof. Patterson

**Project Sponsor**  
Motorola  
Libertyville, Illinois

**Professional Advisor**  
Mr. Jason Wojack

**Faculty Advisor**  
Prof. Eann Patterson

**Team Members and Home Towns**  
Nicole Arnold  
Jackson, Michigan

Johannes Hertrich  
Howell, Michigan

Alex Wright  
White Lake, Michigan



## THE MOTOROLA FOUNDATION YOUTH IN ENERGY & ENVIRONMENT HUMANITARIAN PROJECT: THERMAL SOLAR COLLECTOR DEMONSTRATOR FOR WOODCREEK ELEMENTARY SCHOOL

**W**oodcreek Math, Science, and Engineering Magnet School is a National Magnet School of Excellence located within the Lansing School District. The dedicated teachers at Woodcreek continually provide students in kindergarten through fifth grade with a learning environment that focuses on investigating and studying a broad range of technological fields through interactive activities and valuable, real-world experiments. A portion of this dynamic curriculum concentrates on the basic principles of solar energy. With topics as sophisticated as solar energy, students can greatly benefit from being taught with progressive instructional tools that combine a hands-on experience with visual learning. This project contributes an educational tool that aids these students in their schooling on the powers of thermal energy.

Although there is much debate on the current state of our environment and the effects of global warming, it has been acknowledged by most that we are rapidly depleting much of our natural resources. The utilization of alternative energy through renewable resources is a viable solution to counteract the issue of society's ever increasing energy demands and diminishing access to previous methods of energy production. Renewable energy sources including wind, solar, oceans, rivers, and geothermal heat are readily available, produce zero emissions, and are capable of helping resolve our dependence on non-renewable energy.

The Michigan State University Student Design Team took on the responsibility of teaching the fifth grade students of Woodcreek lessons on the engineering design process, the basics of energy, and the capabilities of solar energy. Through involvement with the thermal solar collector demonstrator project, Woodcreek students gained a working knowledge on the iterative design process through the creation, optimization, and construction of the demonstrator. This project is generously sponsored by the Motorola Foundation through its Youth in Energy and Environment Humanitarian Project, whose main goal is to spark the interest of math and science in children allowing them to "[enhance] the vitality of the communities where [they] do business."

...The Motorola and Woodcreek Elementary School Student Design Team



## A LEAR CORPORATION & CHRYSLER FOUNDATION HUMANITARIAN PROJECT FOR DEVELOPING COUNTRIES: A VACCINE REFRIGERATOR FOR REMOTE REGIONS WITH THE APPROPRIATE TECHNOLOGY DESIGN COLLABORATIVE.

**T**he Appropriate Technology Design Collaborative is a non-profit organization whose goal is creating technologies that are usable and affordable, to help benefit the lives of people in developing countries. All of the designs that the collaborative creates are distributed freely online to anyone who wants to use them or improve upon them.

Over two billion people live without access to electricity. Lack of access to refrigeration is a limiting factor in the dissemination of temperature-sensitive medical supplies within these communities. As a result, 50% of rural vaccines are wasted through spoilage due to lack of cooling. Public health suffers as a quarter of all children born every year – 34 million infants – are not protected against diseases for which there are inexpensive vaccines, and an estimated 2.1 million people around the world die every year of diseases preventable by common vaccines. (WHO 2005)

As the first team of this two-semester project, our goal was to design a refrigeration system for vaccine storage that could be built, maintained, and operated using locally available technology and resources to preserve the potency of lifesaving vaccines so that the second semester's team will be prepared to travel to Tanzania and build a functioning prototype this upcoming spring.

To complete this task, computer models were created to simulate the conditions present in rural Africa, the refrigeration cycle, and the process of harnessing the energy required to operate the designed refrigeration system. Based on these models, a system and components were designed, computer drawings were created, and experimental prototypes of system components were fabricated.

...The Appropriate Technology Design Collaborative Student Design Team



The Appropriate Technology Design Collaborative



The Chrysler Foundation



Ms. Graham



Ms. Raymer



Prof. Somerton

MSU College of Engineering students are bringing Woodcreek Science, Math and Engineering Magnet School's level of teaching up a notch by building a thermal solar collector demonstrator. This tool will help our elementary students, staff, and parents better understand the basics of engineering and thermal solar systems. The school is equipped with solar panels and a solar collector on its roof, which arouses interest in visitors and students. Now, using the thermal solar collector demonstrator, students will be able to make sense of it.

Ms. Diane Graham  
Teacher

**Project Sponsors**  
**Woodcreek Elementary School**  
Lansing, Michigan

**Motorola Foundation**  
Schaumburg, Illinois

**Professional Advisors**  
Ms. Diane Graham  
Ms. Sandy Raymer

**Faculty Advisor**  
Prof. Craig Somerton

**Team Members and Home Towns**  
Bradley Rutledge  
Rochester, Michigan

Zachary Steffes  
Oxford, Michigan

Ryan Stull  
Oxford, Michigan



Mr. Barrie



Prof. Somerton

This project will help people who live without power in the poorest communities on earth to have access to life saving vaccines and medical supplies. Farmers will be able to transport their produce to more distant markets, which will increase their capacity to make money and help communities feed themselves.

John Barrie  
Executive Director  
The Appropriate Technology Design Collaborative

**Project Sponsors**  
**Appropriate Technology Design Collaborative**  
Ann Arbor, Michigan

**Chrysler Foundation**  
Auburn Hills, Michigan

**Lear Corporation**  
Southfield, Michigan

**Professional Advisor**  
Mr. John Barrie

**Faculty Advisor**  
Prof. Craig W. Somerton

**Team Members and Home Towns**  
William Hurles  
Milford, Michigan

Brian Kunkel  
Northbrook, Illinois

Bryce Thelen  
Jackson, Michigan

## CE 495 SENIOR DESIGN IN CIVIL ENGINEERING

**INSTRUCTORS:** Professors Baladi, Hatfield (emeritus) Khire, Maleck, Wallace

**RESEARCH ASSOCIATE:** Haider



Baladi Hatfield Khire Maleck Wallace Haider

### PROBLEM STATEMENT

In this one-semester, required course, six student teams have developed preliminary designs for a new rail/bus transportation facility on the west side of MSU's main campus. The facility will include a rail/bus station, access roads, parking, and storm water facilities. The station will be housed in the lower level of a new multistory building that will be located where MSU's University Housing is now situated; the existing building will be demolished to make room for the new station. The station platform must be 500 feet long and located so that passenger trains do not stop traffic on Harrison Rd. Station parking can be situated east or west of the station and, if necessary, land currently employed for resident parking can be reallocated and improved to provide parking for the new facility. Soil borings obtained for design of the new building's foundation indicate soil/water contamination at the site that will need to be addressed as part of the plan. Engineering designs have been developed for the geometric layout of the roads, the structure of the building that will house the station, the soils that provide the support for this building, the on-site storm water management facilities, the pavement cross sections of the roads and parking areas, as well as, the groundwater cleanup plan.

### PROFESSIONAL EVALUATORS

**Christopher R. Byrum, Ph.D., PE**  
Soil & Materials Engineers  
Plymouth, MI

**George McKenzie, PE**  
NTH Consultants  
Lansing MI

**Michael J. Thelen, PE**  
Soil & Materials Engineers, Inc.  
Lansing, MI

**Daniel Christian, PE**  
Tetra Tech MPS  
Lansing, MI

**John LeFevre, PE**  
FTCH, Inc.  
Lansing, MI

**Phil Vogelsang, PE**  
URS Corporation  
Grand Rapids, MI

**Gregory P. Garrett, PE**  
URS Corporation  
Grand Rapids, MI

**Scott Lidgard, PE**  
DLZ Corporation  
Lansing, MI

**Jeremy Hedden, PE**  
Bergmann Associates, Inc.  
Lansing, MI

**Stanley Mathuram**  
STS Consultants Lts.  
Grand Rapids MI

**Michael C. Isola, PE**  
Bergmann Associates, Inc.  
Lansing, MI

**Tom Myers, PE**  
Wilcox Prof. Services, LLC  
Lansing Mi

**John Saller, PE**  
Wilcox Prof. Services, LLC  
Lansing MI

Award Sponsors



## CE 495 SENIOR DESIGN IN CIVIL ENGINEERING



**Team 1:** Back: Robert Dahmen, Spencer Cain, Brett Scafuri. Front: Andis Berzins, John Kotes, Joel Cutler.



**Team 2:** Back: Elena Yadykina, Jamie Antoniewicz, Brent Morgensen, Keith Troyer. Front: Elise Kapphahn, Jason McCartney.



**Team 3:** Back: Chris Sutton, Thomas Gavin. Front: Angela Rhone, James Robertson, Joseph Podolsky, Kris Steis.



**Team 4:** Back: Matt Chumbley, Katie Wirth. Front: Danielle Dresch, Cara Parks, John Schultz, Andrew Crandall



**Team 5:** Back: Elibe Elibe, Nathan Washburn, Justin Fudge, Jeff Adams. Front: Angela Lierman, Brian Galietti

TEAM	TIME	ROOM
1	8:20 a.m.	MSU Room
2	8:20 a.m.	Lake Michigan Room
3	9:40 a.m.	MSU Room
4	9:40 a.m.	Lake Michigan Room
5	11:00 a.m.	MSU Room

## ELECTRICAL AND COMPUTER ENGINEERING AND MECHANICAL ENGINEERING PROJECTS

### PRESENTATION SCHEDULE —Lake Superior Room

Course Coordinators: Professors Erik Goodman and Craig W. Somerton

Faculty Advisors: Professors Brereton, Brown, Chakrabartty, Deller, DeMaagd, Diaz, Loos, Mukherjee, Oweiss, Ren, and Xiao

Time	Project Sponsor(s)	Sponsor Contact(s)	Faculty Advisor	Project Title
8:00 ECE 480	Lettuce Duit	S. Blosser	K. Oweiss	Accessible Manufacturing Equipment Automated Material Cutter
8:25 ECE 480	Lenovo Corporation	A. Makley J. Swaney	J. Ren K. DeMaagd	Solar-Powered, Multi-user Internet Access for Schools in Developing Nations
8:50 ECE 480	Naval Research Laboratory	V. Gregers-Hansen	T. Brown	Inexpensive Radar for Through-Object Viewing
9:15 ECE 480	Terex Corporation	B. Allen	S. Chakrabartty	Monitoring Rental Equipment Through Telematics
9:40–10:00 Break				
10:00 ME 481/ ECE 480	Biogeochemistry Environmental Research Initiative	N. Ostrom K. Smemo	J. Deller R. Mukherjee	Automated Trace Gas Trapping System
10:50ME 481	Nissan	H. Landis J. Latimer M. Snyder	A. Diaz	Efficient Engine Undercover and Fender Protector
11:15 ME 481	Eaton, Inc.	D. Smith C. Vigus	A. Loos	Next Generation Mylar Fixture
11:40 ME 481	Dow Chemical Company	M. Chappell T. Hogan	X. Xiao	Novel Part Design Replacing Fiberglass with TPO
12:05 ME 481	Dow Chemical Company	L. Hiatt A. Vocaire	G. Brereton	Water Pouches

## LETTUCE DUIT: ACCESSIBLE MANUFACTURING EQUIPMENT AUTOMATED MATERIAL CUTTER

Our sponsor, a Michigan business called *Lettuce Duit*, has many manually operated machines in their factory that are used for general purpose cutting of materials. Currently, workers are manually cutting pleated ribbon material to length using only scissors and rulers. In order to enable workers with various disabilities to perform such tasks efficiently, *Lettuce Duit* wants an automated machine built. The machine must be operable by individuals with disabilities (mainly seeing, hearing, and learning disabilities). Also, in terms of production volume, the machine should be able to at least match the production speed of the individuals who are currently doing the task by hand.

### Sponsor Specifications:

- Machine will be manually fed material by the user, and the machine can then complete the operation with minimal input
- Machine can accurately cut material to a length of 0.1 to seventeen inches, with 0.1 inch resolution
- Machine must be accessible to persons with disabilities
- Machine has simple user interface, with audio/visual feedback for those with hearing/seeing impairments
- Material to be cut will have width no greater than two inches
- Machine will be electrically and mechanically safeguarded
- Machine must be reasonably portable

<http://www.egr.msu.edu/classes/ece480/goodman/spring/group01>



Vinod Natla  
Electrical Eng



Kyle Coveart  
Electrical Eng



Jeli Joegiono  
Electrical Eng



Ryan Everaert  
Electrical Eng



Mr. Blosser



Prof. Oweiss



**Project Sponsor**  
*Lettuce Duit*

**Sponsor Representative**  
Mr. Stephen Blosser

**Faculty Facilitator**  
Dr. Karim Oweiss

**Team Members Non-Technical Roles**

Vinod Natla  
Project Manager

Jeli Joegiono  
Presentation/Lab Coordinator

Ryan Everaert  
Document Prep

Kyle Coveart  
Webmaster



## LENOVO CORPORATION: SOLAR-POWERED, MULTI-USER INTERNET ACCESS FOR SCHOOLS IN DEVELOPING NATIONS

In cooperation with *Lenovo*, the MSU Department of Telecommunication, Information Systems and Media, and the University of Dar es Salaam, our design team was tasked with creating a multi-terminal, Internet-enabled, solar-powered computer system for deployment in rural regions of developing nations. The target deployment zones are remote impoverished areas of the world. These places lack basic amenities including electric power. Village schools in such areas lack textbooks, libraries, and other tools to provide their children good formal education. By creating a solar-powered computing and information resource for schools in such regions, we can help to improve education around the globe.

TISM students have identified and obtained a low-power bidirectional satellite link usable in Africa. We have integrated a solar panel, battery, multiple monitors, keyboards, a computer system, power monitoring and control unit, and the satellite link into a single, self-contained unit. Testing mainly focuses on system stability and performance in the harsh environment of Maasailand in Tanzania.

Our chosen approach was to configure a computer acting as a central server and multiple dumb terminals for the users. This is all powered by solar panels that charge a large marine battery that supplies a DC-to-AC power inverter. We have built monitoring and control circuitry between all parts of the system, allowing us to gauge the battery life left in the system and to identify possible system upgrades. Broader contributions by the distributed team also include identification of suitable internet resources, in Swahili and English, for initial use in the schools.

<http://www.egr.msu.edu/classes/ece480/goodman/fall08/group02>



Ben Kershner  
Computer Eng



Eric Tarkleson  
Electrical Eng



Josh Wong  
Computer Eng



Jakub Mazur  
Electrical Eng



## NAVAL RESEARCH LAB: INEXPENSIVE RADAR FOR THROUGH-OBJECT VIEWING

Detection and discrimination of live and inanimate radar targets through building walls holds great utility for public safety and disaster relief agencies. Numerous through-wall life detection schemes have been developed in recent years, but their utility has been dampened by excessive cost. The 2004 Indian Ocean tsunami and 2008 earthquake in China are prime examples of widespread disasters where the ability to quickly determine if living humans were trapped behind building rubble might have saved numerous lives. A low-cost through-obstruction life detection device may have saved countless people who survived the initial disaster, only to succumb after days trapped beneath rubble.

The *Naval Research Laboratory*-sponsored design team developed a proof-of-concept radar system with the ability to detect movement through walls or other obstructions. The radar system uses a National Instruments CompactRIO chassis for data acquisition and signal processing. The design team investigated a key problem with portable through-wall radars; namely, receive sensitivity loss due to self-interference inherent in compact linear FMCW (frequency modulated continuous wave) radars. Loss of sensitivity means the radar cannot "see" as deeply through obstructions or detect smaller targets due to self-interference. Low-cost embedded microprocessors and microwave devices available as COTS items enable interference-cancelling capabilities. The final product from the design team is a compact through-wall radar system using a laptop PC for near real-time display of the one-dimensional target data.

<http://www.egr.msu.edu/classes/ece480/goodman/fall08/group04>



A. Aqel  
Computer Eng



G. Warnell  
Computer Eng



M. Weingarten  
Electrical Eng



S. Warren  
Computer Eng



M. Volz  
Electrical Eng



Prof. Jian Ren



Prof. Kurt DeMaagd  
Telecomm Facilitator

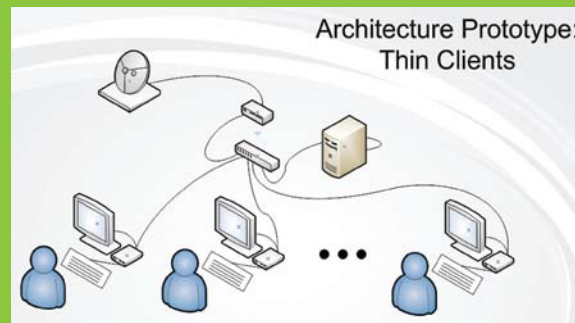

System architecture demonstrating the use of low power dumb terminals passing the workload off to a central server.

**Project Sponsor**  
*Lenovo Corporation*

**Sponsor Representatives**  
Al Makley  
John Swansey

**Faculty Facilitators**  
Dr. Jian Ren  
Dr. Kurt DeMaagd

**Team Members Non-Technical Roles: MSU College of Engineering:**  
Jakub Mazur  
Manager

Benjamin Kershner  
Documentation

Eric Tarkleson  
Presentation/Lab

Joshua Wong  
Webmaster

**MSU Communication Arts and Science**  
Joe Larsen  
Tor Bjornrud  
Telecommunications

**University of Dar es Salaam**  
Victor Crallet  
Telecommunications

Louis Magali  
Electric Power



Mr. Gregers-Hansen



Prof. Brown

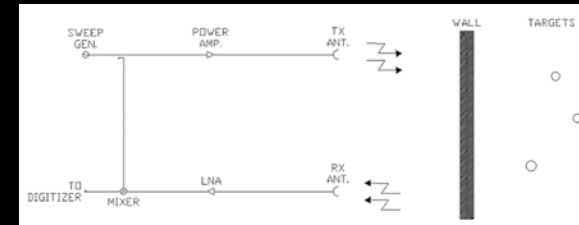

**Project Sponsor**  
*Naval Research Lab.*

**Sponsor Representative**  
Mr. Wilhelm Gregers-Hansen

**Faculty Facilitator**  
Dr. Terence Brown

**Team Members Non-Technical Roles**  
Michael Volz  
Manager

Scott Warren  
Webmaster

Garrett Warnell  
Documentation Prep

Michael Weingarten  
Presentation Prep

Ali Aqel  
Lab Coordinator

## TEREX CORPORATION: MONITORING RENTAL EQUIPMENT THROUGH TELEMATICS

Recently large construction companies and companies providing heavy equipment for lease have significantly increased their interest in monitoring the equipment that they rent or own using telematics. This communications technology, often used on cranes and heavy construction equipment, can provide information about the location and activity of all equipment to a user at a computer anywhere in the world.

This project, sponsored by Genie, a subsidiary of *Terex*, will consist of the hardware design of components necessary to gather information from existing sensors on construction equipment, and the software necessary to send that information wirelessly to a purchased on-site communications hub. This hub will have a monthly service fee, and will transmit the equipment's data via satellite to a user interface provided to the private customer. The focus of the project will be to transmit data to the user interface that shows specifically the amount of time that a particular machine has been in operation. This information is extremely useful to the customer when renting out their equipment, or when scheduling regular maintenance.

<http://www.egr.msu.edu/classes/ece480/goodman/fall08/group05>



A. Harden  
Electrical Eng  
K. McGrail  
Electrical Eng

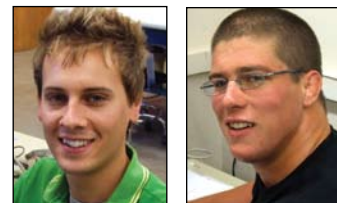

R. Jankowski  
Electrical Eng  
J. Murphy  
Electrical Eng

## BIOGEOCHEMISTRY ENVIRONMENTAL RESEARCH INITIATIVE: AUTOMATED TRACE GAS TRAPPING SYSTEM

Our team has designed and constructed an Automated Trace Gas Trapping System (ATGTS) that will be used to monitor trace gas amounts of nitrous oxide ( $N_2O$ ) and carbon dioxide ( $CO_2$ ) emissions from soil to the atmosphere. Using a series of molecular sieve and desiccant traps in conjunction with a micro-diaphragm pump and solenoid valves, the system will measure the  $N_2O$  and  $CO_2$  released from soil every four hours. This process will repeat for a one month time period until the traps are replaced and sent to a laboratory to quantify the gas measurements.

Our multi-disciplinary team, consisting of ME and ECE students, is working in conjunction with Dr. Nathaniel Ostrom of the MSU Department of Zoology and Dr. Kurt Smemo of Case Western Reserve University. Utilizing funding from the *Biochemistry Environmental Research Initiative*, we have created a device that accurately monitors the ambient temperature and humidity levels wherever the ATGTS is deployed to collect data. The ATGTS will play an active role in comparing  $N_2O$  and  $CO_2$  soil emissions from no-till farm practices and more conventional farm methods. The intention is that this data will serve as a basis for participation in greenhouse gas emission accounting programs by educators and farmers.

<http://www.egr.msu.edu/classes/ece480/goodman/fall08/group07/>



D. Cashen  
Electrical Eng  
C. Gliniecki  
Electrical Eng  
A. Kerstien  
Mechanical Eng



T. Hancasky  
Computer Eng  
J. Kowalski  
Mechanical Eng  
A. Grisdale  
Mechanical Eng



A. Esbrook  
Electrical Eng



Mr. Allen



Prof. Chakrabarty

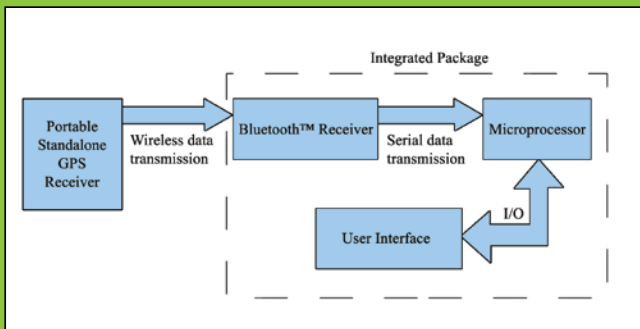

**Project Sponsor**  
Terex Corporation

**Sponsor Representative**  
Dr. Brad Allen

**Faculty Facilitator**  
Dr. Shantanu Chakrabarty

**Team Members Non-Technical Roles**  
Kevin McGrail  
Manager

Adam Harden  
Webmaster

Rob Jankowski  
Documentation Prep

John Murphy  
Lab Coordinator  
Presentation Prep



Dr. Smemo



Dr. Ostrom



Dr. Deller



Prof. Mukherjee

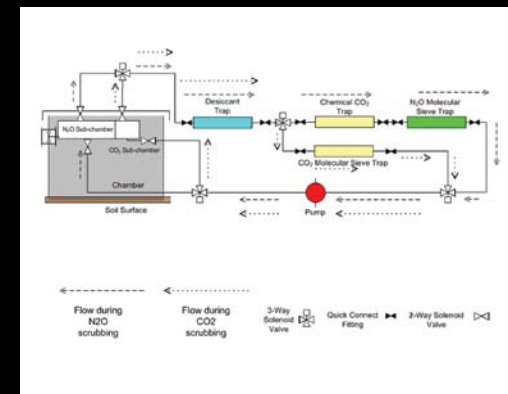

**Project Sponsor**  
Biogeochemistry  
Environmental  
Research Initiative

**Sponsor Representatives**  
Dr. Nathaniel Ostrom  
Dr. Kurt Smemo

**Faculty Facilitators**  
Dr. John Deller  
Dr. Ranjan Mukherjee

**Team Members Non-Technical Roles**  
Daniel Cashen  
Manager

Thomas Hancasky  
Chris Gliniecki  
Co-Webmasters

Alex Kerstein  
Josh Kowalski  
Co-Documentation Prep

Alex Esbrook  
Adam Grisdale  
Co-Presentation Prep



## NISSAN: EFFICIENT ENGINE UNDERCOVER AND FENDER PROTECTOR

**N**issan has demonstrated a commitment to innovation since the company's founding in 1933. Nissan has nearly doubled the number of models offered and nearly doubled in sales. Nissan continues to move in a positive direction not only for the sake of a better driving experience but to also improve customer satisfaction.

The Nissan Altima is one of Nissan's best-selling vehicles in North America. The project tasks include enhancing the efficiency of the Altima's engine undercover and fender protector design in order to reduce cost, weight, and aerodynamic drag. Additionally, improving the assembly process and product durability will reduce warranty costs for Nissan.

Currently, Polypropylene (PP) and Polyethylene (PE) thermoplastics are injection-molded to form the five components of the plastic assembly. Parts include left and right fender protectors and splash guards, as well as an engine undercover. This assembly is utilized in the vehicle to protect the undercarriage from road debris, deflect water, and ventilate the engine compartment.

Research on alternate manufacturing processes, materials, and geometries were performed to find the most effective design. New parts were then modeled in computer aided design programs and subjected to stress analysis tests. Constraints such as Nissan's durability and quality specifications as well as goals of reducing cost, weight, and drag were closely monitored.

...The Nissan Student Design Team



Ms. Landis



Mr. Snyder

Altima is Nissan's highest selling vehicle in North America. Improving the Altima's engine Undercover and Fender Protector Efficiency will play a major role in Nissan's goal to reduce part and warranty costs. It will also improve fuel economy due to mass reduction and improved aerodynamics. Overall, this project will lead to improved customer satisfaction while at the same time benefiting Nissan.

Mr. Mark Snyder  
Nissan Technical Center



Mr. Latimer



Prof. Diaz

**Project Sponsor**  
Nissan Technical Center  
Farmington Hills, Michigan

**Professional Advisors**  
Ms. Heather Landis  
Mr. John Latimer  
Mr. Mark Snyder

**Faculty Advisor**  
Prof. Alejandro Diaz

**Team Members and Home Towns**  
Tony Davis  
Benton Harbor, Michigan

Ravi Jadia  
Troy, Michigan

Hani Kobty  
Abu Dhabi, United Arab Emirates

Vivek Sarasam  
Hyderabad, India



## EATON: NEXT GENERATION MYLAR FIXTURE

**T**he Eaton Aerospace plant located in Jackson, Michigan, is responsible for manufacturing and assembling a wide variety of fluid conveyance lines for planes and helicopters, ranging from commercial to military applications. To ensure that these lines function properly, the design specifications associated with each configuration must be extremely accurate. However, the current procedures used to assemble and check these pipes require either substantial time for setup (between one and three hours), or employ bulky, cost-ineffective devices that reduce the plant's available storage space.

Therefore, the goal of this project was to design a reconfigurable device that greatly reduces the setup time associated with measuring conveyance line specifications. Additionally, the proposed device would be able to maintain the position of these tubes while allowing a worker to apply welds where needed. Finally, the device would have the capability of simple transport throughout the entire plant and might even be transported outside of the plant when outsourcing is needed. Together, these changes will yield major cost savings for Eaton.

To accomplish this task, the project team analyzed the current fixture and setup process to determine improvement criterion. The new design seeks to automate the processes currently done by hand and employ a sensor system to ensure that tolerances are met. With these improvements, the project team hopes to revolutionize the way in which fluid conveyance lines are manufactured and checked.

...The Eaton Student Design Team



Powering Business Worldwide



Mr. Vigus



Prof. Loos

The Next Generation Mylar Project is a key element in Eaton's strategy to reduce costs in our manufacturing processes to remain globally competitive with our Jackson, Michigan Aerospace site. The current technology has been in use for decades; and while it is the industry standard, it is a very manual and time consuming process. There is a potential to save hundreds of thousands of dollars per year if we can reduce the time it takes to set up our variable-geometry Mylar Fixtures - and the concepts pursued by the MSU team are very promising.

Clint Vigus  
Engineering Manager  
Eaton Aerospace

**Project Sponsor**  
Eaton, Inc.  
Jackson, Michigan

**Professional Advisors**  
Mr. Daniel Smith  
Mr. Clint Vigus

**Faculty Advisor**  
Prof. Alfred Loos

**Team Members and Home Towns**  
Chris Hunley  
Jackson, Michigan

Zachary McIntyre  
Jackson, Michigan

Scott Slingerland  
Rochester Hills, Michigan

Kipp Wallace  
Chicago, Illinois



## THE DOW CHEMICAL COMPANY: NOVEL PART DESIGN REPLACING FIBERGLASS WITH TPO

The Dow Chemical Company, headquartered in Midland Michigan, is dedicated to driving human development. Dow specializes in performance chemicals and plastics and has a rich history of achievements ranging from the invention of SARAN WRAP® to the development of epoxy resins used to fabricate the heat shield of Apollo 8. Today, with 46,000 employees worldwide, Dow designs and produces innovative materials used in a variety of industries including agricultural, automotive, construction, chemical processes, cleaning, electronics, food, photography, medical, and textiles.

The objective of this project was to redesign the fiberglass front end-cap of a RV so that it could be thermoformed out of INSPIRE D500. This material is a thermoplastic polyolefin (TPO) and is produced by Dow specifically for large part thermoforming. The novel, end-cap design generated by the student team took advantage of the strengths of INSPIRE D500, while remaining within its limitations. The design process consisted primarily of three steps. First, models of various end-cap designs were created using CAD software. Next, the behavior of each model was predicted using FEA, and the results were used to select the best of the original models. Lastly, software was used to optimize the selected design so as to maximize its stiffness while satisfying numerous constraints such as manufacturability, weight, cost, and aesthetic appeal. The final design demonstrated that it can be both feasible and profitable to thermoform large components out of the specialized TPO. By showing that this new technology can perform similarly to traditional fiberglass, this project should improve industry awareness of the capabilities of INSPIRE D500 and accelerate its widespread acceptance.

...The Dow Chemical Company Student Design Team



## DOW CHEMICAL: WATER POUCHES

Bottled water is an ever increasing market in the US, with over \$15 billion in sales in 2007 alone; and with Americans throwing out 30 million bottles a day, this becomes a major waste management problem. Dow Chemical aims to aid this problem with the development of its new resin that will make pouched water a feasible option. Pouched water will greatly reduce manufacturing costs due to the decrease in material being used, as well as a significant decrease in waste volume. Previously, due to the process of ozonating water, pouched water was not an option until now. Dow Chemical has asked us to develop a design for a water pouch that is easy to open, tamper resistant, aesthetically pleasing, lightweight, and can be marketed to bottling companies as an alternative to the traditional rigid water bottle.

Ozonated water is the type of water found in 95% of the bottled water market today. Ozonated water undergoes a process that adds extra oxygen to the water for sanitation reasons. Unfortunately, when ozonated water is placed in plastic pouches, it reacts with the materials and affects the taste of the water. Dow Chemical has developed a layer of resin that can be used as a barrier between the water and pouch that eliminates this reaction from occurring. In order to convince consumers to make the switch to pouches, they must demonstrate quality and convenience, while remaining environmentally friendly.

...The Dow Chemical Student Design Team



Mr. Hogan



Prof. Xiao

The design of an improved part using Dow's INSPIRE D500 Performance Polymer in the replacement of fiberglass will enable the current users and future users of D500 to realize the potential of the material. A rigorous design analysis will be important for both Dow and OEM's to take advantage of the physical and processability characteristics of the material while maintaining the structural integrity of the current fiberglass part.

Todd Hogan  
Senior Development Specialist  
The Dow Chemical Company

**Project Sponsor**  
The Dow Chemical Company  
Midland, Michigan

**Professional Advisors**  
Mr. Mark Chappell  
Mr. Todd Hogan

**Faculty Advisor**  
Prof. Xinran Xiao

**Team Members and Home Towns**  
Jacob Kloss  
Harbor Springs, Michigan

Lauren Sharp  
Wixom, Michigan

Christopher Sweeney  
Holt, Michigan



Ms. Hiatt



Mr. Vocaire



Prof. Brereton

Working with the Engineering program at MSU provides The Dow Chemical Company with the unique opportunity to design a new product that will not only be functional but will virtually guarantee the acceptance of a young and sophisticated generation of consumers. The team will have to perform adequate market research, ergonomic development, and in-use product testing in order to design a successful water pouch prototype. We are excited and looking very forward to the outcome of this important project!

Andrew Vocaire  
Market Development Manager  
The Dow Chemical Company

**Project Sponsor**  
Dow Chemical Company  
Midland Michigan

**Professional Advisors**  
Ms. Lindsay Hiatt  
Mr. Andrew Vocaire

**Faculty Advisor**  
Prof. Giles Brereton

**Team Members and Home Towns**  
Brielle Meadows  
Fowlerville, Michigan

Justin Milburn  
Milford, Michigan

Brandon Quaranto  
Canton, Michigan

Kevin Wright  
Highland, Michigan



## MECHANICAL ENGINEERING PROJECTS

### PRESENTATION SCHEDULE –Tower Room

Course Coordinator: Professor Craig W. Somerton

Faculty Advisors: Professors Haddow, Hong and Mr. Chalou

Time	Sponsor(s)	Project Contact(s)	Faculty Advisor	Project Title
8:00 ME 481	Kellogg Biological Station Dairy Farm	M. Hann	B. Chalou	Alternative Energy Power System for the Kellogg Biological Station Dairy Farm Expansion
8:25 ME 481	Terex-Demag	A. Klein	A. Haddow	Wheel Module Development for All-Terrain Crane
8:50 ME 481	General Motors	J. Calderas T. Micale	S. Hong	LED Light Pipe Reuse Strategy

## KELLOGG BIOLOGICAL STATION DAIRY FARM: ALTERNATIVE ENERGY POWER SYSTEM FOR THE KELLOGG BIOLOGICAL STATION DAIRY FARM EXPANSION

The Kellogg Biological Station is an MSU field station devoted to researching and understanding natural and managed ecosystems as well as conservation of natural resources. It is a division of the MSU College of Agriculture and Natural Resources along with the College of Natural Science and is located between Kalamazoo and Battle Creek, Michigan. This is a 4,065 acre facility made up of smaller stations, which include the Kellogg Bird Sanctuary, Kellogg Farm, the Kellogg Biological Laboratories, the KBS Conference Center, Extension and Outreach offices, the Lux Arbor Reserve, and the KBS Dairy Center.

The goal of this project was to propose a sufficient and efficient power system for the upcoming addition to the *Kellogg Biological Station Dairy Farm*, utilizing sources of alternative energy. The addition to the farm will include a new robotic milking center and expansion to over 200 head of cattle.

The group first had to assess the current power situation of the farm to determine an appropriate alternative energy system that would be powerful and reliable enough to work year round. The system also had to be hospitable for the local wildlife being studied in the area. Several different types of systems were studied to propose one that would sustain the farm with an alternative energy source including wind turbines, solar panels, and methane digesters. The solution to the energy need was determined using a hybrid system, incorporated into the current energy grid. In addition, sources of funding and creating an educational experience for visitors of the farm were imperative.

.... The KBS Student Design Team



Mr. Haan



Mr. Chalou

The Michigan State University Kellogg Biological Station is currently constructing a new pasture-based dairy facility designed to meet Leadership in Energy and Environmental Design (LEED) certification as defined by the Green Building Rating System. The design and incorporation of a renewable energy system into the dairy will provide a clean renewable energy source, further reducing the environmental impacts of the dairy. More importantly, it will serve as an example and educational tool for farmers and others in Michigan and around the country as to how they can incorporate renewable energy into their lives and decrease their own impact on the environment.

Mr. Matthew Haan  
Specialist-Outreach  
Kellogg Biological Station  
Dairy Farm

### Project Sponsor Kellogg Biological Station Dairy Farm

Hickory Corners,  
Michigan

### Professional Advisor

Mr. Mathew Haan

### Faculty Advisor

Mr. Bob Chalou

### Team Members and Home Towns

Justin Bauer  
Marysville, Michigan

Emily Duszynski  
Cynthiana, Kentucky

Daejung Kim  
Seoul, South Korea

Keith Tenbusch  
Bad Axe, Michigan

## TEREX-DEMAG: WHEEL MODULE DEVELOPMENT FOR ALL-TERRAIN CRANE

**T**erex-Demag, based in Germany, has been designing and manufacturing mobile cranes for more than 50 years and is the leading innovator in mobile crane technology. The company's diverse product line features All-Terrain-Cranes, which have the ability to drive on the road and in rough terrain. During crane operations the crane is elevated on outriggers which level the crane and provide an enhanced base for stability. Depending on the size of the crane, these outriggers are either transported on the crane or on separate trucks due to weight regulations on the road. The ideal AT crane would be able to travel on the road, transport the largest boom possible, and integrate the outriggers onto the chassis. To achieve this, engineers are on a constant search to save weight on the chassis, outriggers and other components.

*Terex-Demag's* "Octopus" concept is based on the idea of combining the chassis and outriggers. The structure consists of four movable outriggers located around a slew gear that contain the drive wheels and can be arranged in parallel to each other for driving. This leads to many complications in terms of the stability of the design on the road. The tires opposite one another cannot be arranged on fixed axles but must be able to steer, brake, and drive, making drive-by-wire a necessary feature.

The main task for the MSU team was to develop a concept for a wheel module including mechanics, electrics, hydraulics, and a description of the required control functions. The wheel module provides the following functions: carrying the vehicle load, braking the vehicle, driving the vehicle, and steering the vehicle. The packaging constraints including forces and outline dimensions for the wheel module have been defined in coordination between the MSU team and the *Terex-Demag* development team.

...The *Terex-Demag* Student Design Team



Prof. Haddow

The cooperation with the MSU students delivers the unique opportunity to step into a completely new technological field with many challenges, enabling all faculties of engineering students to participate and strive to new horizons in crane technology in terms of mechanical, electrical and hydraulic concepts. The Octopus is based on a *Terex-Demag* patent, which offers high potential for future mobile All-Terrain-Cranes.

Dr. Ascan Klein  
Manager Design Telescopic Cranes, Development & Projects  
*Terex-Demag*

**Project Sponsor**  
*Terex-Demag*  
Zweibrücken,  
Germany

**Professional Advisor**  
Dr. Ascan Klein

**Faculty Advisor**  
Prof. Alan Haddow

**Team Members and Home Towns**  
Andrew Gryczan  
Grand Rapids, Michigan

Richard Hollern  
Grand Rapids, Michigan

Jonathan Luckhardt  
Big Rapids, Michigan



## GENERAL MOTORS: LED LIGHT PIPE REUSE STRATEGY

**A**s the largest vehicle manufacturer in the world, *General Motors* continues to raise the bar when introducing new technology to the automotive industry. One such technology, the Light Emitting Diode (LED) light pipe, made great strides in vehicle style when it was introduced in the 2008 Cadillac CTS, winner of the 2008 Motor Trend Car of the Year.

The goal of this project was to create a new, aesthetically pleasing LED light pipe that can be used in headlamps of multiple vehicles, specifically the 2008 Chevrolet Tahoe and the 2008 GMC Yukon Denali. The design of this LED light pipe had to meet a demanding list of government regulations in order to be legal in the United States, Canada, and Europe. The final design will aide *General Motors* to efficiently add light pipes to several new vehicles without developing a new light pipe for every application. In addition, this project will enhance the development of an Exterior Light Pipe Best Practice for future applications.

To complete this development of a new, generic LED light pipe, existing LED light pipe technology was researched and initial designs were developed. With the help of Osram Sylvania, a world-wide leader in consumer lighting, several designs were tested to meet all government regulations through Computer Aided Engineering (CAE). The CAE analysis included optical ray-tracing and thermal effects testing, which ultimately determined the basis of the light pipe design. With several iterations, the design was optimized according to several design parameters and the final prototype was fabricated. This final prototype was then tested under all *General Motors* validation tests, including an optics test, a three-axis vibration test, and a thermal performance test. With this new design strategy, *General Motors* will meet the demands of the customer by manufacturing aesthetically enhancing light pipes in larger quantities, and at a lower cost.

...The *General Motors* Student Design Team



Mr. Caleras and Mr. Micale

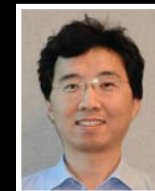

Prof. Hong

In order to remain competitive, *GM* must develop low-cost, reusable light pipe technology as part of its leadership tradition in the marketplace. This strategy further supports *GM's* global effort to reduce costs, mass, warranty, and development time with minimal risk. The reusable light pipe also enables *GM* styling to design even more aesthetically appealing lamps to further attract buyers to *GM* vehicles.

Mr. Tony Micale  
Group Manager  
Exterior Lighting  
*General Motors*

**Project Sponsor**  
*General Motors*  
Warren, Michigan

**Professional Advisors**  
Mr. Jeffrey Calderas  
Mr. Tony Micale

**Faculty Advisor**  
Prof. Soonsung Hong

**Team Members and Home Towns**  
Christopher Erwin  
DeWitt, Michigan

Drew Mosner  
Beverly Hills, Michigan

Neal Spitzley  
Westphalia, Michigan

Richard Wahl  
DeWitt, Michigan



# CHE 434

Course Information  
for Capstone  
Spring 2009



Prof. Hawley



Prof. Berglund

## PROCESS DESIGN AND OPTIMIZATION I

**INSTRUCTORS: Professor Martin Hawley and Professor Kris Berglund**

### ChE 433 Process Design and Optimization I

It is the goal of this course to develop competence in chemical process design. This is accomplished by students solving a series of design problems increasing in complexity from a single piece of equipment to a complete manufacturing plant. The students are asked to solve these problems under simulated industrial conditions, preparing and presenting recommended designs in written reports to management. The course is integrative in nature, drawing from previous courses in the basic sciences, chemical engineering and other engineering sciences. Students typically solve five or six chemical engineering design problems during the semester that require the ability to apply this previously gained knowledge. Also, topics related to economic evaluation, optimization, decision-making and risk are included at appropriate times during the course as they relate to design.

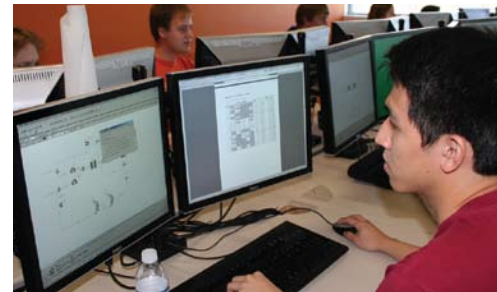

### CAPSTONE - SPRING 2009 CHE 434 PROCESS DESIGN AND OPTIMIZATION II

CHE 434 is a logical extension of CHE 433. The abilities developed through efforts in CHE 433 are now applied to a problem extending over a somewhat longer period of time. It requires more initiative, enterprise, care, and a greater measure of individual responsibility

#### The American Institute of Chemical Engineers (AIChE) Problem

MSU Chemical Engineering has the best record in the nation for placing in this national contest since 1967!

Each year, chemical engineers from a designated company devise and judge a student contest problem that typifies a real, working, chemical engineering design situation. The problem's solution requires a wide range of skills in calculation and evaluation of both technical data and economic factors. Michigan State has the best placement record of any department in the country and we are pleased to continue the trend!

For example, a recent problem involves designing a semi-batch reaction process for manufacturing polyethers. Polyethers are an important family of products that are used in many consumer products such as detergents, foams, and food additives. The design project involves determining the best design (both economic and safe) for the facility. The design features that use inherently safe concepts that circumvent accidents even when instruments fail or operators make mistakes are emphasized.

## A world leader in automotive parts and accessories

Delphi designs, engineers and manufactures a wide variety of components, integrated systems and modules on a worldwide basis. As the largest and most diversified supplier of automotive parts, Delphi can provide our vehicle manufacturer customers with global, single-point sourcing capability and systems tailored to meet their specific needs.



<http://delphi.com/>

**DELPHI**

**Brake Systems**  
Automotive Holdings Group



# Design Day Awards:

MICHIGAN STATE COLLEGE OF ENGINEERING

## Computer Science and Engineering Awards

CSE 498, Collaborative Design, is the senior capstone course for students majoring in computer science. Teams of students design, develop, and deliver a significant software system for corporate clients. The CSE capstone teams competed for the four prestigious awards described below. The winners were selected on Design Day by a panel of distinguished judges.



Team 2: The Boeing Company – Poseidon Executor 2008  
l-r: Nick Thrower, Steve Emelander, Scott Walenty, Tom Stark  
Presented by Bob Buchanan of Auto-Owners Insurance



Team 3: Ford Motor Company – Ford Sensor Showroom  
l-r: Austin Drouare, Colin Nemchik, Devin Schnepf, Nathan Crosty.  
Presented by Karen Wrobel of Chrysler



Team 10: The Toro Company – WPF-Based Interface for Irritrol  
l-r: Stephanie Cook, Dan Fioridalis, Matt Grabow  
Presented by Kevin Ohl of Crowe Horwath



Team 6: Microsoft – MUD: A Web-Based Multi-User Drawing Surface. l-r: Rob Meyer, Sean Murphy, Kirsten Parryka, Charles Otto. Presented by Tony Lambert of TechSmith



**Auto-Owners Exposition Award**  
CSE 498 capstone teams present their projects on Design Day in a variety of ways. Teams create and set up an exhibit where they demonstrate their software systems and answer questions to Design Day attendees. Each team will play their project videos and answer questions for a panel of judges. The CSE capstone team with the best overall Design Day performance will be honored with the Auto-Owners Exposition Award, which is sponsored by Auto-Owners Insurance Company of Lansing, Michigan.



**Chrysler Praxis Award**  
One of the hallmarks of CSE 498 capstone projects is that of praxis, the process of putting theoretical knowledge into practice. Teams apply a wide variety of information technologies to produce solutions to complex problems in areas such as business, engineering, computing, and science. The CSE capstone team that engineers the software system that is the most technically challenging will be recognized with the Chrysler Praxis Award, which is sponsored by Chrysler LLC of Auburn Hills, Michigan.



**Crowe Sigma Award**  
The CSE 498 experience represents the capstone of the educational career of each computer science major. An intense semester of teamwork produces impressive deliverables that include a formal technical specification, software, documentation, user manuals, a video, a team web site, and Design Day participation. The resulting sum of the capstone experience is much greater than the parts. The capstone team that delivers the best overall capstone experience will be recognized with the Crowe Sigma Award, which is sponsored by Crowe Horwath LLP of Oak Brook, Illinois.



**TechSmith Screencast Award**  
Each CSE 498 capstone team produces a video that describes and demonstrates their software product. Starting with a storyboard and a script, teams use Camtasia Studio 5 to synthesize screen recordings, video, audio and other multimedia to produce their project videos. And the TechSmith Screencast Award goes to the CSE capstone team with the best project video. The award is sponsored by the creators of Camtasia Studio, TechSmith of Okemos, Michigan.

### Design Day Judges for CSE Awards: April 2008

Kevin Ohl  
Executive Partner  
Crowe Horwath LLP

Erica Ciupak  
CIO, College of Agriculture  
and Natural Sciences  
Michigan State University

Naim Falandino  
Software Architect  
Covisint

Matt Mutka  
Professor and Chairperson,  
Computer Science and  
Engineering  
Michigan State University

Karen Wrobel  
Senior Manager  
Chrysler LLC

Brian Loomis  
Global Architect  
Microsoft



# Design Day Awards:

MICHIGAN STATE COLLEGE OF ENGINEERING

## Mechanical Engineering: Thomas Alva Edison Undergraduate Design Award

The Edison Scholars are recognized as the ME 481 Design Team that has produced the most outstanding project. A jury of experts from industry and academia evaluate the final reports, the posters, and the final oral presentations in determining the award winners. Teams operating under ME 481 that include members from other departments and colleges are also eligible for this award. The funding for this award is provided by the Shell Oil Company.



*l-r: Professor Somerton, Darius Libiran, Bryan Wagenknecht, Kyle Szykiel*

### SPRING 2008 ME 481 EDISON UNDERGRADUATE DESIGN AWARDS

First Place	Second Place	Third Place
MSU Department of Chemical Engineering and Materials Science: Electron Microscope In-Situ 4-Point Bend Apparatus Darius Libiran Steven Poon Kyle Szykiel Bryan Wagenknecht	General Motors Corporation: Low Noise Exhaust Tips Marcus Colon George Mullonkal Ryan Rieck Nicholas Rowe	General Motors North American Engineering: Best Execution of a Zero Drag Automotive Brake System David Klipfel Cody Priess Brian Smith Joshua Thomet

## ME 481 Oral Presentation Award

The best ME 481 oral presentation as determined by the ME 481 students is recognized with this award.

### SPRING 2008 ME 481 ORAL PRESENTATION AWARDS



*l-r: Professor Somerton, Cody Priess, Joshua Thomet, Brian Smith, David Klipfel*

First Place	Second Place	Third Place
General Motors North American Engineering: Best Execution of a Zero Drag Automotive Brake System David Klipfel Cody Priess Brian Smith Joshua Thomet	Kraft: Resealable Package Pete Foltz Daniel Little Ryon Lockhart Jin Tam Lane Taber Scott Wiltz	Whirlpool Corporation Eco-efficiency Components for a Clothes Dryer Andrew Abramowski Aaron Butler Patrick Cadigan Aaron Hall

## ME 481 Outstanding Poster Award

The ME 481 Outstanding Poster Award recognizes the best poster presented by an ME 481 design project team as judged by a team of individuals from industry and academia. Judging is based on both technical content and aesthetic layout.



*l-r: Professor Somerton, Cody Priess, Joshua Thomet, Brian Smith, David Klipfel*

### SPRING 2008 ME 481 POSTER PRESENTATION AWARD

First Place	Second Place	Third Place
General Motors North American Engineering: Best Execution of a Zero Drag Automotive Brake System David Klipfel Cody Priess Brian Smith Joshua Thomet	A Shell Oil Company Humanitarian Project for People with Disabilities: Redesign of Recumbent Cycle for MidMichigan Medical Center Pinal Desai Kalpen Gandhi Bret Hollier Gerald Landry	Borg Warner Thermal Systems: Forced Conduction Clutch Base Design Michael Cooper Paul Crockett Michael Hagedorn Justin Rumao

# Design Day Awards:

MICHIGAN STATE COLLEGE OF ENGINEERING

## ME 456 Mechatronics Systems Design Commercial Mechatronic Product Award

The best ME 456 commercial product and prototype presented at the Student Design Conference is recognized with this award. The award winners are determined by the course instructional staff.

*l-r: Professor Radcliffe, Richard Henderson, Brian Smith, Daniel Little, Keith Bury*

### FALL 2007 ME 456 MECHATRONIC PROTOTYPE AWARD



First Place	Second Place	Third Place
The "Pedal Stop" Locking Bicycle Rack Keith Bury Richard Henderson Daniel Little Brian Smith	The Chore Checker Adam Grisdale Kyle Koepf Christopher Sweeney	The "No Fret" Guitar Tuner Andrew Kosinski Martin Priess Bryan Wagenknecht

## ME 412 Heat Transfer Laboratory Heat Transfer Design Award

The student team members winning the ME 412 competition at Design Day are recognized by the Heat Transfer Design Award. The award winners are determined by the course instructor based on team scoring in the competition.

*l-r: Cody Priess, Brian Smith, Professor Somerton, Bryan Wagenknecht*

### SPRING 2008 ME 412 HEAT TRANSFER DESIGN AWARD



First Place	Second Place	Third Place
Cody Priess Brian Smith Bryan Wagenknecht	Erin Johnson Daniel Little Jacob Wagner	Brandon Bouchard Tiffany DiPetta Keith Tenbusch

## ME 371 Mechanical Design I Kids' Choice Award

The pre-college students participating in Design Day vote for the most outstanding ME 371 project. The winning team is designated as the Kid's Choice Award. This team is recognized with a plaque designed and manufactured by Mr. Jon Thon's 7th grade technology class at Holt Junior High School.

### SPRING 2008 ME 371 KIDS' CHOICE AWARD

First Place	Second Place	Third Place
Louis Cervone Jacob Haf Dan Materson Matthew Perelli	Muhammad Nabeel Aslam Chris Gandy Kayton Lenhart Krishna Vistarakula	Tim Francisco Brandon Hengesbach Steve Hukill Imoh Eno-Idem

## ME 371 Mechanical Design I Award: Spring 2008



*l-r: Ben Llewellyn, Lauren Heitzer, Andy Rogers, Drew Darling*

First Place	Second Place	Third Place
Drew Darling Lauren Heitzer Ben Llewellyn Andy Rogers	Bryant Ennis Ashley Kulczycki Andrea Vivan Marissa Wiltz	Paul Allen Chris Miller Mackenzie Schmidt

## ME 471 Leonardo da Vinci Scholar Award: Spring 2008

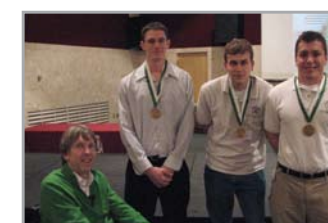

*l-r: Professor Haddow, Kyle Elliott, John Tysman, Richard Hollern*

First Place	Second Place	Third Place
Kyle Elliott Richard Hollern John Tysman	Christopher Cater Derek Riparip Vivek Sarasam	Kevin Derrick Patrick Hammer Brent Rowland

# Design Day Awards:

MICHIGAN STATE COLLEGE OF ENGINEERING

## Electrical and Computer Engineering Prism VentureWorks Prize and Winners, Spring, 2008

The Prism VentureWorks Prizes (\$1,500, \$1,000, and \$500, respectively) are awarded each semester to the most outstanding teams in the Electrical and Computer Engineering Senior Capstone Design Course, as judged by a panel of engineers from industry. A team with members from both ECE and another engineering major (mechanical engineering, for example) is also eligible, if the team's project is administered through ECE 480. The prizes are sponsored by Prism VentureWorks, a Boston-based venture capital firm, and Mr. William Seifert, an ECE alumnus, who is a partner in that firm. The faculty and students of Electrical and Computer Engineering are very grateful for this generous support.

### First Place: Team #9 – Electrical Conductivity Tester for Railroad Ties (Sponsor: Norfolk Southern)



LEFT TO RIGHT:  
Dr. Erik Goodman, Bradley J. Graca, Paul M. Anselmi,  
Vikram J. Singh, Ahmad Nashriq Abdulmutalib, Julian Quick

### Second Place: Team #2 – Sip-and-Puff Interface to an All-In-One Controller (Sponsor: MSU RCPD and Chrysler Foundation)



LEFT TO RIGHT:  
Dr. Erik Goodman, Petar Jovanoski, Kenneth Kleszcz,  
Borce Dilevski, Kelly Kryskowski, Richard J. Cantor

### Third Place: Team #6 – DigiDriveIV™ Platform Development (Sponsor: Gormley Systems Engineering)



LEFT TO RIGHT:  
Nicholas Patino, Kyle C. Raeb, Benjamin M. Urban,  
Fred M. Fishbeck, Devin D. Looney

# Design Day Awards:

MICHIGAN STATE COLLEGE OF ENGINEERING

## Professor's Choice Award and Winner, Spring, 2008

The Professor's Choice Award (\$1,500 and a certificate) is given each semester by the faculty member teaching ECE 480, Senior Capstone Design, to the team judged to have done the most to achieve the objectives of the course and sponsor, particularly taking into account the varying levels of challenge of the projects assigned. Judging is based on reading of the teams' final reports, examination of their posters/prototypes, and communication with their faculty facilitators.

### Team #4 - Sparty Tank T-Shirt Shooter (Sponsor: MSU Intercollegiate Athletics)



LEFT TO RIGHT:  
Dr. Erik Goodman,  
Adam J. Sneller, Alex B. Lai,  
Timothy Tran, Danny D. Tran,  
Christopher D. Ballard,  
Blake Gower, Bryan Grinnell,  
Kyle Koepf

## Electrical and Computer Engineering Capstone Poster Award and Winner, Spring, 2008

Each team in ECE 480, Senior Capstone Design, exhibits a poster and the items they have built during the semester and they also will answer questions from 8:00am-noon in the Union Ballroom. Judging of the best poster/demo is done by the groups of high school students participating in Design Days, based on their appeal and effectiveness in communicating the project goals and achievements. A prize of \$1000 is awarded to the most outstanding team.



LEFT TO RIGHT:  
Dr. Erik Goodman, Nicholas Tram, Marquise W. Abbey, Matt Jastrzebski,  
Ian Michael McLaurin, Almir Mujkic

## Civil Engineering Senior Design Award

The Civil Engineering Senior Design Award (\$600 and plaques) is presented to the best team in CE 495 as judged by the faculty and a panel of practicing engineers.

Each student participates on a team which, as a collective unit, is responsible for preparing a project design. Individual student's responsibilities within the team are focused on one of the following technical-specialty areas: environmental, geotechnical, hydrological, pavements, transportation, or structures. Each student is responsible for preparation of a technical report. Midway through the semester, each student meets one-on-one with a practicing professional engineer to summarize his/her progress. The final technical reports are judged by faculty and the oral presentations of each team's overall design are judged by a board of six professional engineers.

The faculty and students of the Department of Civil and Environmental Engineering gratefully acknowledge the generous contributions from Fishbeck, Thompson, Carr & Huber, Inc. (FTC&H) and from Barr Engineering Co. These companies currently make this award possible. FTC&H is a professional civil engineering, environmental consulting, architectural/engineering, and construction management firm with clients in Michigan and throughout the nation. Barr is a professional engineering company providing engineering, environmental, and information technology services to clients across the nation and around the world.





## REMEMBER WHEN YOUR CAREER CHOSE YOU?

FINDING SOMETHING YOU'RE PASSIONATE ABOUT doesn't happen every day, so when you do find it, you embrace it. At Boeing, we believe passion is what fuels our innovations and inspires our employees to be more than they ever thought possible. As we continue on our journey to amazing destinations, we want you to help take us there. You'll be joining an organization known for its support of learning both on and off the job, and one that has also been honored as higher education's top corporate sponsor. The job categories below include some of the key skills we are seeking.

- Aeronautical Engineering
- Aerospace Engineering
- Business/Finance
- Chemical Engineering
- Civil Engineering
- Electrical Engineering
- Electromagnetic Engineering
- Embedded Software Engineering
- Industrial Engineering
- Manufacturing Engineering
- Material Science Engineering
- Mechanical Engineering
- Optics
- Payloads
- Physics/Math
- Propulsion
- Reliability Maintainability Testability Engineering
- Software Engineering
- Structures
- Systems Engineering

To view a comprehensive listing of all available positions, please visit: [boeing.com/collegecareers](http://boeing.com/collegecareers)  
Security clearance requirements are indicated in the position listings. U.S. citizenship is necessary for all positions requiring a security clearance.

Boeing is an equal opportunity employer supporting diversity in the workplace.

Apply at: [boeing.com/collegecareers](http://boeing.com/collegecareers)



## *The Dart Foundation Day for 7th-12th Grade Students*

# "Our future lies in some very precious hands..."

Our children are our future. Without the next generation of engineers, scientists and other professionals, the advances we enjoy today would quickly grind to a halt.

At the Dart Foundation, we are committed to developing scientifically literate students in Michigan. Therefore we are delighted to help fund the MSU Department of Mechanical Engineering's Design Day for pre-collegiate students.

An investment in our children's future will pay big dividends for this generation, and also generations yet unborn, in Michigan, America and ultimately the world.



## The Dart Foundation Day 7th-12th Grade Students

### Thursday December 4, 2008 MIDDLE SCHOOL EVENTS SCHEDULE

EVENTS	8 a.m.	9 a.m.	10 a.m.	11 a.m.	Noon
EGR 100 Cornerstone Poster Session		Ballroom (Front) 9:00 a.m. - noon			
Audio Enthusiasts & Engineers	2nd Floor Concourse 8:00 a.m. - 1:00 p.m.				
Engineering Student Organizations		2nd Floor Concourse 9:00 a.m. - noon			
Schools Welcome		2nd Floor Concourse 8:40 - 8:55 a.m.			
Student Organization and Project Judging		Ballroom 9:00 - 12:15 p.m.			
Electronic Digital Thermometer Build		Parlor B 9:00 a.m. - 12:15 p.m.			
Science & Engineering for a New Energy Infrastructure Presentation		Parlor C 9:00 a.m. - 12:15 p.m.			
NXT Robotics		Ballroom (Back) 9:00 a.m. - 12:15 p.m.			
Awards Ceremony	Ballroom (Back) 12:15 p.m. - 12:25 p.m.				
Lunch for all participants		Ballroom (Back) 12:30 p.m. - 1:00 p.m.			

KEY:  All Participants  Middle School Event

#### 2nd Floor, Parlor B ELECTRONIC DIGITAL THERMOMETER BUILD: FOR MIDDLE SCHOOL



This build is specifically designed to help middle school students gain understanding of introductory electronics theory and application. In this session students will get an introduction to basic electronics, learn to solder, and create a class set of thermometers for their school. They will be taught how to properly handle and place those components onto the Printed Circuit Board (PCB). Once the build is completed students will have an opportunity to learn how to calibrate their thermometers. Throughout the build, MSU faculty and engineering students will help students test and trouble-shoot as needed. Upon successful completion of this session each school will have a classroom set of thermometers to enhance mathematics and science activities in their school's curriculum.

#### 2nd Floor, Ballroom (Back) NXT ROBOTICS



Our team of experts has designed a lab experience to give the middle school students an introduction to robots. Students will experience programming of their robot using the Lego NXT Mindstorm Robot. Using the graphical software (NXT G), students will write programs to control their group robot. Student teams will experiment with robotic programming. Application and discovery of how programming works will be similar to lessons presented in science and math classes. Each team will discover how to adjust their programs based upon the program inputs and actual output. During each phase, new challenges will be introduced to engage the student, reinforce new ideas and concepts and expose the teams to the newly emerging capabilities of student-controlled robotics programs.

### Thursday and Friday 2nd Floor, Parlor C SCIENCE AND ENGINEERING FOR A NEW ENERGY INFRASTRUCTURE



**Tonghun Lee**  
Energy and Automotive Research Laboratory  
Department of Mechanical Engineering

As demand for fossil fuels increases in almost every corner of the world, and the environmental impact of combustion are more apparent, there is an unprecedented need for advanced technology which can provide energy from alternative sources and ultimately reduce our dependence on foreign oil. This presentation will show why today's energy issues are so important, provide insight into key problems and examine how science and engineering can bring profound changes.

The first part of the presentation will focus on the evolution of human civilization, technical innovations which have had great impact in our lives and the need for a revolutionary change in our energy infrastructure. The second part of the presentation will provide an in-depth perspective of the energy issue and why it is so important to our nation. The final part of the presentation will discuss potential solutions which can bring alternative and renewable energy into our everyday lives.

## The Dart Foundation Day 7th-12th Grade Students

### Friday December 5, 2008 HIGH SCHOOL EVENTS SCHEDULE

EVENTS	8 a.m.	9 a.m.	10 a.m.	11 a.m.	Noon
Audio Enthusiasts & Engineers	Billard Room 8:00 a.m. - 1:00 p.m.				
Engineering Student Organizations and Poster Judging		2nd Floor Concourse 9:00 a.m. - noon			
Schools Welcome		2nd Floor Concourse 8:30 - 8:45 a.m.			
Student Organization and Project Judging		Ballroom 8:45 - 12:00			
Wireless (WIMS) Thermometer Build		Parlor B 8:45 a.m. - 12:00			
Science & Engineering for a New Energy Infrastructure Presentation		Parlor C 8:45 a.m. - 12:00			
Civil Engineer Tower Build		Ballroom 8:45 a.m. - 12:00			
NXT Robotics		Green Room 8:45 a.m. - 12:00			
Student Voting Awards		Ballroom 12:00 a.m. - 12:10 p.m.			
Lunch for all participants		2nd Floor Concourse 12:10 - 1:00 p.m.			

KEY:  All Participants  High School Event

#### MEMBERS OF THE ORGANIZING COMMITTEE:



Jamie Lynn Marks  
Michigan State University  
Recruitment and K-12 Outreach



Drew Kim  
Asst. to Dean and Recruitment and K-12 Outreach



Russ Pline  
Okemos High School and MSU Design Day Coordinator



Bob Watson  
K-12 Outreach FIRST LEGO League Coordinator



John Thon  
Holt Junior High School MSU Design Day Coordinator

#### 2nd Floor, Parlor B WIRELESS INTEGRATED MICROSYSTEMS (WIMS) DIGITAL THERMOMETER BUILD



In this session students will get an introduction to basic electronics, learn to solder, and create a class set of thermometers for their school. The WIMS initiative integrates

science, math, and engineering through hands-on/minds-on builds to instill excitement and curiosity about the fields of engineering. Students will learn to identify basic electronic components and discuss their functions. Additionally, they will be taught how to properly handle and solder those components onto the Printed Circuit Board (PCB). Once the thermometers are completed we will test them and trouble-shoot as needed. At the end of this session you will have a classroom set of thermometers that will transmit data to your computer via a base-station.

#### 2nd Floor, Parlor C SCIENCE AND ENGINEERING FOR A NEW ENERGY INFRASTRUCTURE PRESENTATION

See explanation of event at the bottom of the opposite page (page 62)

#### 2nd Floor, Green Room NXT ROBOTICS

See explanation of event on opposite page (page 62)

#### 2nd Floor, Ballroom CIVIL ENGINEER TOWER BUILDING



Humans have been building towers since we first started erecting structures thousands of years ago. Are the pyramids simply towers with wide bases necessary to support a structure of their tremendous height and weight? Towers also hold up bridges such as the Mackinac Bridge and the Golden Gate Bridge. Towers like the

Sears Tower in Chicago are capable of housing offices, businesses, or living spaces. We also use towers to project radio signals beyond the curvature of the earth. This is accomplished by broadcasting the signal from a great height. The higher the tower, the greater the distance of the broadcast without interference from the Earth. This brings us to our challenge today. Given limited amounts of space and material, how does an engineer design a tall tower that is able to support a load while remaining stable? You and your team will need to figure this out!

# THANKS TO NORFOLK SOUTHERN



The Department of Electrical and Computer Engineering thanks Norfolk Southern for its generous financial support of Design Day. This support was used for production of this program and for other costs associated with Design Day, and for the infrastructure that allows our ECE Senior Capstone Design teams to work effectively on their industry problems.

Norfolk Southern Railway has a proud history, and today's NS includes not only the Norfolk and Western Railway and Southern Railway from which its name arose, but also all or large parts of many other historic railroads, such as the Pennsylvania Railroad, Nickel Plate Road, and Conrail. We are proud to have Norfolk Southern as a sponsor of Design Day! They recruit engineers (not locomotive engineers, but electrical engineers, computer engineers, etc.) at Michigan State University.



*The Future of Transportation*

# THANKS TO THE CHRYSLER FOUNDATION

Chrysler Foundation has made a generous grant that provides the opportunity for teams of electrical and computer engineering students to work on humanitarian projects that assist persons with disabilities. This semester's project will design and prototype manufacturing equipment that is more usable by persons with disabilities, opening up to them new possibilities for earning a livelihood. Last semester's projects were enhancements to the electronics used in the game of Beep Baseball, played by people with visual impairments, and development of an inexpensive but powerful device for control of household appliances and electronic devices, designed for activation by sipping and puffing on a straw, for users without the use of hand/foot muscles. Last year, students developed other new hardware for Beep Baseball and also developed a portable audio-visual book reader based on an MP-3 player.



The students' experiences prepare them for a life of engineering with a new perspective on universal design, and an appreciation of the personal satisfaction arising from working with enabling technology. We thank the Chrysler Foundation for their generous support of these teams and of the Design Day activities!

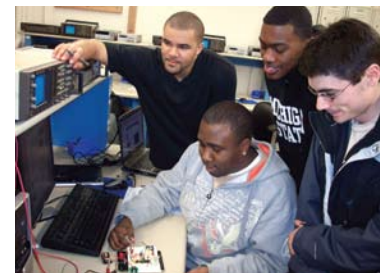

## The Chrysler Foundation

